

MCI GEL™ XtalSpeed™

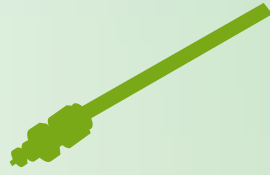

TECHNICAL INFORMATION
2022-2023





MCI GEL™ XtalSpeed™

Excellent performance

spherical and sharp particle size distribution

Persistence and highest quality

offers packing materials and packed columns,
under strict quality control

Wide range of product line

MCI GEL™ has been designed based on technology of
the world famous Diaion™ and Sepabeads™,
specialized in polymeric packing materials including
from analytical to preparative use,
for ion exchange, reversed-phase mode

Abundant accumulation of technology and experience

for more than 50 years, MCI GEL™ has been used for
HPLC applications

DIAION™ SEPABEADS™

Reaction catalysts



Purification of sugar



Purification of foods and food additives



Purification of medicine



70th

Mitsubishi Chemical is building on more than 70 years of experience in ion exchange manufacturing. We continue to aim to achieve a truly KAITEKI society signifying a sustainable condition that delivers comfort for people, society and Earth.

Ion Exchange Resin



Water treatment for boiler



Ultra pure water for electric devices



Water treatment for power plants

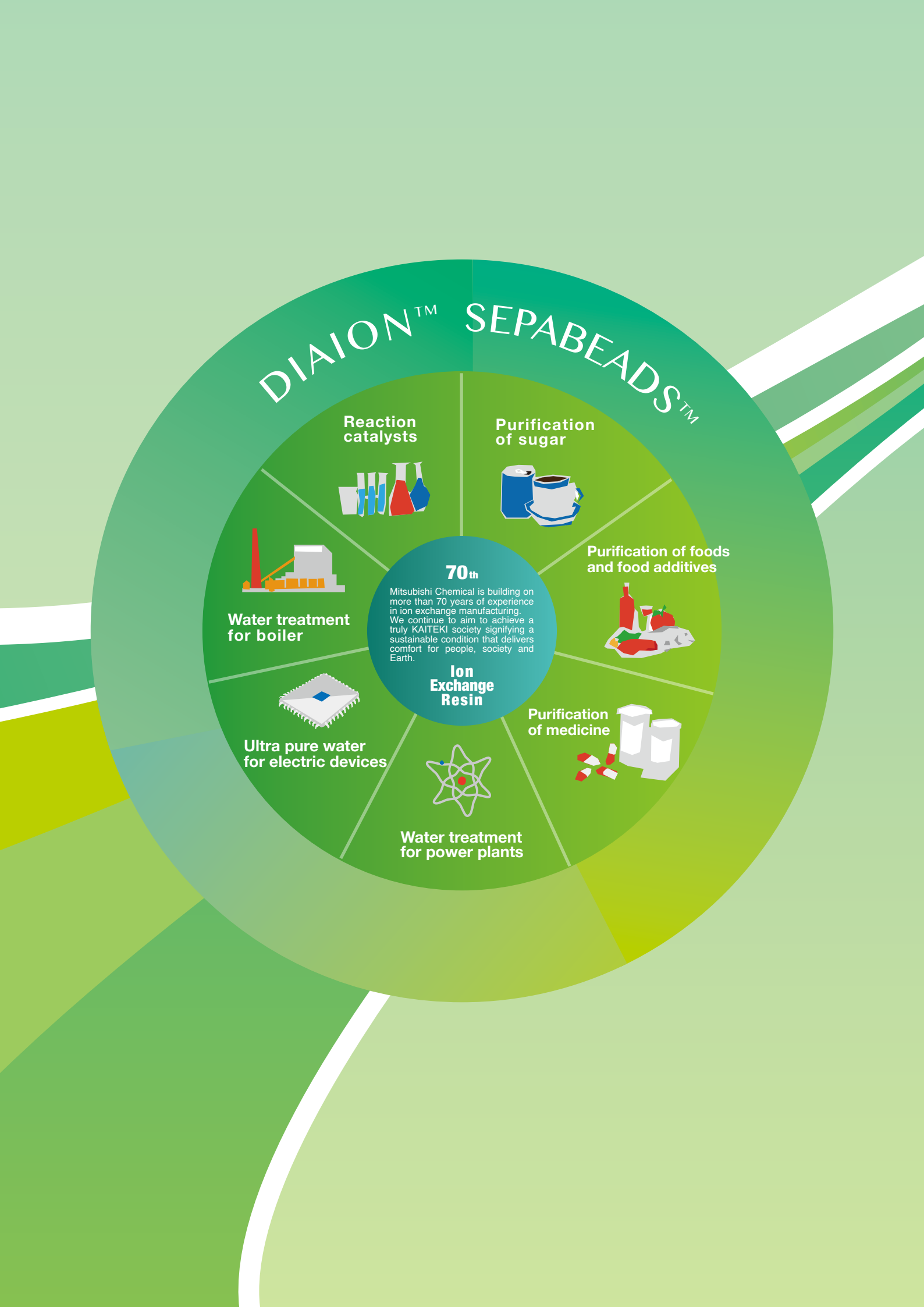

CONTENTS

1 Column selection guide	3~4
Column selection guide	3
Product list by particle size and separation mode	4
USP List	4
2 Ion exchange columns and materials	5~20
Features	5
Column list and materials	6
[Applications] Sugars•Sugar alcohols•Organic acids《CK08,06 series》	7~12
Examples of peak retention time 《CK08E series》	13
Oligosaccharides 《CK04S•CK04SS•CK02A•CK02AS》	14~16
Amino acids《CK10U》	17~18
Sugars•Organic acids 《CA08F》	19~20
3 Ion chromatography columns and materials	21~25
Column list and materials	21~22
[Applications] Cations 《SCK01》	22~23
Cations 《CHK45》	23
Anions 《SCA04》	24~25
4 Bioseparation columns and materials	26~30
Bioseparation columns	26
Ion exchange chromatography column《XtalSpeed™ series》	27~28
Column list and materials	27
[Applications] Rituxan《XtalSpeed™ series》	28
Aqueous size exclusion columns 《CQP series》	29~30
Size exclusion chromatography columns	29
Column list and materials	29
[Applications] Calibration curves 《CQP series》	30
Proteins•Water soluble polymers 《CQP series》	30

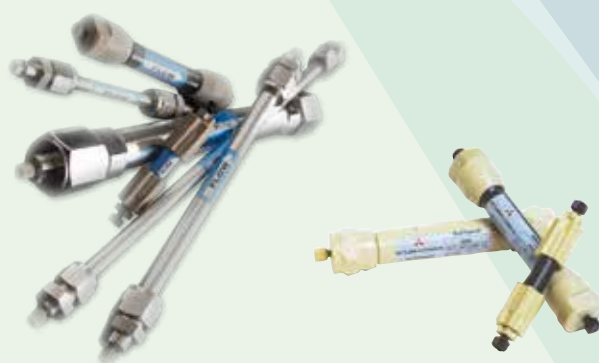

5 Analytical and preparative chromatography columns and materials for pharmaceutical applications 31~51

Polymeric partition chromatography columns and materials MCI GEL™ CHP series	31
Separation mechanism of CHP series	31
Column list	32
Column durability	33
[Applications] Organic compounds • Insulin • Peptide «CHP column series»	34~46
Polymeric chromatography materials «CHP material series»	47~54
Chromatography material list	47
[Applications] Organic compounds «CHP material series»	48~51

6 Chiral separation columns 52~57

Separation mechanism of CRS series	52
[Applications] Optical isomers «CRS10W • CRS15W»	53~56
Separation conditions for various amino acids	57

7 SPE sorbent series 58

Solid phase extraction sorbents	58
Synthetic adsorbents and reversed-phase material list	58
Chelating type list	58

8 MCI GEL™ column list 59~60

9 MCI GEL™ material list 61~64

10 Compounds index 65~72

Nature of sample

Separation mode

MCI GEL™ column

pH range

Applications

Pages

Nature of sample	Separation mode	MCI GEL™ column	pH range	Applications	Pages		
Sample	Water Soluble	M.W. >2,000	Size Exclusion	CQP10 CQP30	2 ~12	Proteins, Biopolymers Water soluble polymers	29~30
			Ion Exchange	XtalSpeed™	2 ~12	Proteins, Antibody	27~29
			Reversed-Phase	CMG20 CHPOD CHP20 CHP07	2 ~12 Full range	Proteins, Peptides Proteins, Peptides	31~51 31~51
		M.W. <2,000	Size Exclusion	CK02A CK02AS CK04S CK04SS	6 ~7 6 ~7	Oligosaccharides Oligosaccharides	14~16 14~16
			Ion Exclusion	CQP06 CK10U CA08F	2 ~12 1 ~14 1 ~13	Peptides Amino acids Organic acids Saccharides	29~30 17~18 19~20
			Ion Chromatography	SCA04 SCK01 CHK45	3 ~7 1.5~12	Anions Cations	21~25 21~23
	Organic Solvent Soluble	Reversed-Phase	CMG20 CHPOD CHP20 CHP07	2 ~12 Full range	Organic Compounds peptide Organic Compounds peptide	31~51 31~51	
		Mix mode	CHK40 CHK45	Full range	Amino acids, Nucleotide	32,43~46	
		Ion Exclusion	CK08EH	1 ~7	Organic acids	7,11~12	
		Ligand Exchange	CK08E Series	1 ~7	Saccharides	7~13	
			CRS10W CRS15W	5 ~7	Optical isomers (α-amino acids* α-hydroxy carboxylic acids)	52~57	
		Reversed-Phase	CHP20 CMG20 CHP07	Full range	Organic Compounds	31~51	
Normal Phase	CMG20 CHPOD	2 ~12	Organic Compounds	31~51			
Mix mode	CHK40 CHK45	Full range	Organic Compounds	32,43,46			

● Product list by particle size and separation mode

Separation mode	Particle size [μm]	Analytical		Preparative				
		5	10	30	50	150		
Ion exchange	XtalSpeed™	CK	CK	CK	CK		CK	
			CA	CA	CA		CA	
Ion chromatography	CHK45 SCA		SCK					
Size exclusion			CQP					
Normal phase	CHP20/C04		CHP20/C10	CHP20/P20	CHP20/P30	CHP20/P50	CHP20/P70	CHP20/P120
			CSP50/P10	CHP50/P20	CHP50/P30			
	CHP07/C04		CHP07/C10					CHP07/P120
	CMG20/C04		CMG20/C10					
			CMG20/P10		CMG20/P30			
	CHPOD/C04				CHPOD/P30			CHP85/P120 CHP87/P120
Mix mode	CHK40 CHK45							
Ligand exchange	CRS							

● USP LISTING OF MCI GEL™

USP Code	PACKING	MCI GEL™ Column	Page
L17	Strong cation-exchange resin consisting of sulfonated cross-linked styrene-divinylbenzene copolymer in the hydrogen form, 6 to 12 μm in diameter	CK08EH	7
L19	Strong cation-exchange resin consisting of sulfonated cross-linked styrene-divinylbenzene copolymer in the calcium form, 5 – 15 μm in diameter	CK08EC	7
L21	A rigid, spherical styrene-divinylbenzene copolymer, 3 to 30 μm in diameter	CHP20/C04 CHP20/C10	32
L25	Packing having the capacity to separate compounds with a molecular weight range from 100-5000 (as determined by polyethylene oxide), applied to neutral, anionic, and cationic water-soluble polymers. A polymethacrylate resin base, cross-linked with polyhydroxylated ether (surface contained some residual carboxyl functional groups) was found suitable	CQP06	29
L31	A hydroxide-selective, strong anion-exchange resin-quaternary amine bonded on latex particles attached to a core of 8.5-μm macroporous particles having a pore size of 2000 Å units and consisting of ethylvinylbenzene cross-linked with 55% divinylbenzene	SCA04	21
L32	A chiral ligand-exchange resin packing-L-proline copper complex covalently bonded to irregularly shaped silica particles, 5 to 10 μm in diameter	CRS10W CRS15W	52
L37	Packing having the capacity to separate proteins by molecular size over a range of 2,000 to 40,000 Da. It is a polymethacrylate gel	CQP30	29
L38	A methacrylate-based size-exclusion packing for water-soluble samples	CQP10 CQP30	29
L39	A hydrophilic polyhydroxymethacrylate gel of totally porous spherical resin	CMG20/C04 CMG20/C10	32
L58	Strong cation-exchange resin consisting of sulfonated cross-linked styrene-divinylbenzene copolymer in the sodium form, about 6 to 30 μm diameter	CK08S CK08E CK04S CK02A	6
L71	A rigid, spherical polymethacrylate, 4 to 6 μm in diameter	CMG20/C04	32

- Cation exchange resins
MCI GEL™ CK series
- Anion exchange resins
MCI GEL™ CA series

Mitsubishi Chemical Ion Exchange Resins

MCI GEL™ specializes in polymer based packing materials. Specifically, polystyrene polymer based ion exchange resins are derived from over 50 years of manufacturing experience of Diaion™ product line. MCI GEL™ ion exchange resins for HPLC have been developed with the same attention to performance and quality. For several decades, Mitsubishi Chemical has been providing MCI GEL™ ion exchange columns are offered in a variety of chemistries, particle sizes and counter ions to support a broad range of applications.

Features

1. **Variety of products** gel type, porous type, DVB%, particle size, particle size distribution
analytical use, preparative use
2. **Persistence of high quality, excellent separation performance**
3. **Accumulation of abundant knowledge and experience of applications**

Ion exchange resins are generally used for analysis of amino acids, sugars, organic acids and amines, etc. MCI GEL™ custom pre-packed columns are specifically designed for each application using the most appropriate packing material among our product line and using the most suitable column dimensions.

Typical application for each column is shown in this catalog. These data will suggest an appropriate column.

● Chemical structure of ion exchange resin

〈Strongly acidic cation exchange resin〉

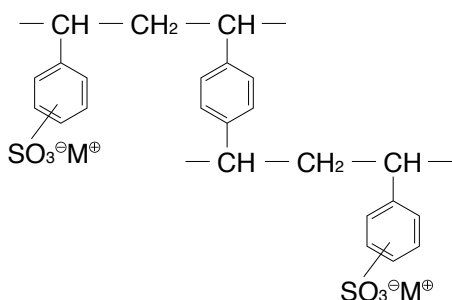

〈Strongly basic anion exchange resin〉

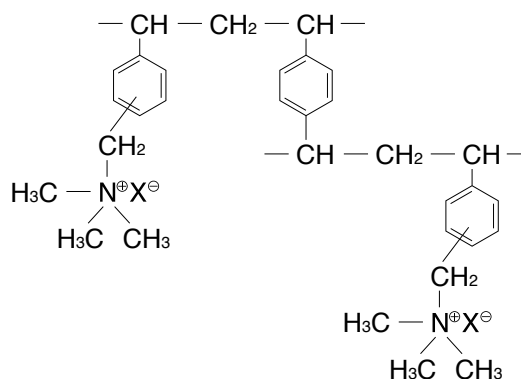

● MCI GEL™ columns for HPLC

	Description						Typical usage					
	Product name	Column dimensions I.D×L [mm]	Packing material			USP	Amino acid	Mono saccharide	Oligo-saccharide	Carboxylic acid	Amine	Physiological fluid
			Cross linkage [%]	Counter ion	Particle size [μm]							
MCI GEL™ Cation exchange columns	MCI GEL™ CK10U	6×120	10	Na ⁺	5		○				○	
	MCI GEL™ CK08S	8×500	8	Na ⁺	11	L58		○				
	MCI GEL™ CK08E	8.0×300 7.8×300	8	Na ⁺	9	L58		○				
	MCI GEL™ CK08EC	8.0×300 7.8×300	8	Ca ²⁺	9	L19		○				
	MCI GEL™ CK08EH	8.0×300 7.8×300	8	H ⁺	9	L17		○		○	○	
	MCI GEL™ CK06SC	8×500	6	Ca ⁺	11			○	○			
	MCI GEL™ CK04S	10×200	4	Na ⁺	11	L58			○			
	MCI GEL™ CK04SS	10×200	4	Ag ⁺	11				○			
	MCI GEL™ CK02A	20×250	2	Na ⁺	20	L58			○			
	MCI GEL™ CK02AS	20×250	2	Ag ⁺	20				○			
MCI GEL™ Anion exchange columns	MCI GEL™ CA08F	4.6×250	8	SO ₄ ²⁻	7			○		○		

● Packing materials

Packing materials are available. Please look at P.62 and P.63.

● Description of a gel type ion exchange column

MCI GEL™ CK08EC

for HPLC use

Cation=K
Anion=A

DVB%

Counter ion

(no letter=Na⁺, C=Ca²⁺
S=Ag⁺, H=H⁺)

Particle size (mode)

(A=20μm, S=11μm
E=9μm, F=7μm,
U=5μm)

● Note ; Pre-column and guard column

1. Please consider using a guard column concerning purity of injection sample. Guard columns, are listed in the end of this catalog, should be selected in accordance with a main column.
2. As for analysis of amino acids by MCI GEL™ CK10U, MCI GEL™ AFR2-PC is recommended as a pre-column. The AFR2-PC column is very effective to stabilize base line because it can trap ammonium ion in eluent. A peak caused of the ammonium ion may disturb base line stability.

CK08,06 series

Cation exchange columns applications; sugars, carboxylic acids, (poly)alcohols, etc.



CK08EC 8×300, 7.8×300

CK08EH 8×300, 7.8×300

● Column list

MCI GEL™ column	Counter ion	Application areas	USP
MCI GEL™ CK08S MCI GEL™ CK08E	Na ⁺	General sugar separation columns	L58
MCI GEL™ CK08EC	Ca ²⁺	The most general sugar separation column Highly recommended for fructose and glucose This column conforms to US Pharmacopeia.	L19
MCI GEL™ CK08EH	H ⁺	Organic acids with H ₃ PO ₄ eluent; sugars with distilled water eluent	L17
MCI GEL™ CK06SC	Ca ²⁺	Use for analysis of mono-saccharides and disaccharides.	

Application data of CK08EC

Fig. 2-1 Sugars

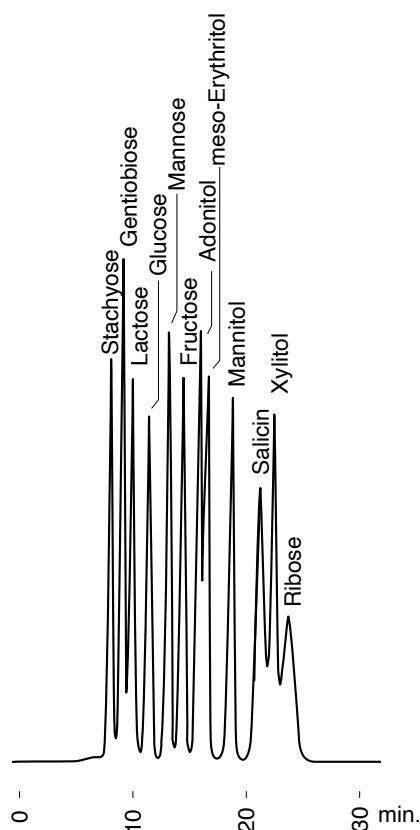
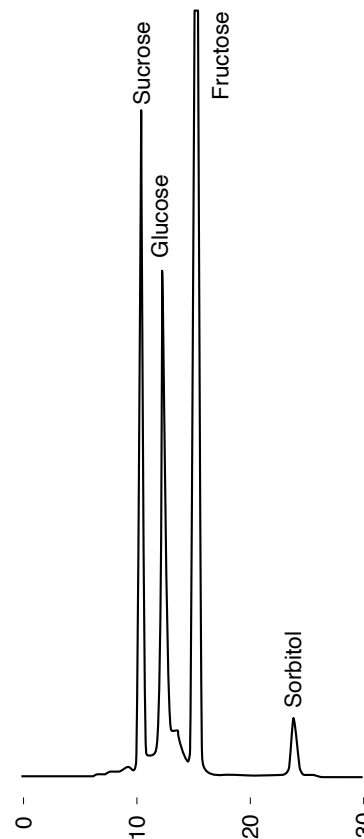
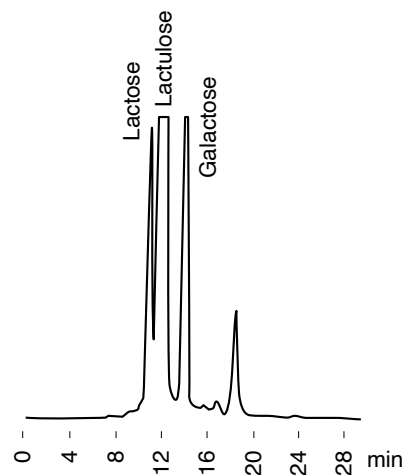

Fig. 2-2 Apple juice



Conditions
 Column : MCI GEL™ CK08EC
 8mm I.D.×300mm
 Eluent : H₂O
 Flow rate : 0.6mL/min
 Column temp. : 75°C
 Detection : RI

Fig. 2-3 Lactulose syrup



Application data of CK08EC

Fig. 2-4 Sports drink A

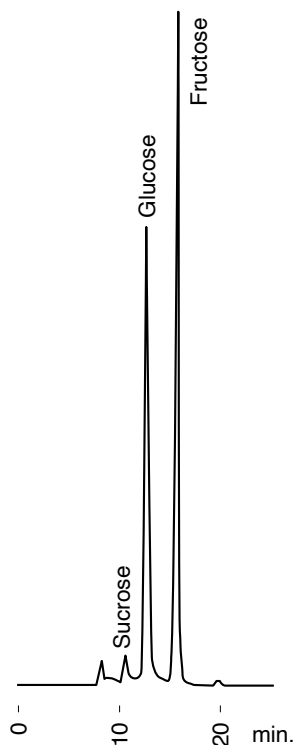

Fig. 2-5 Sports drink B

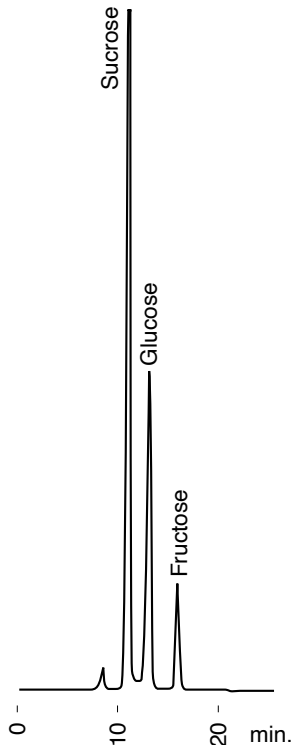

Fig. 2-6 Honey

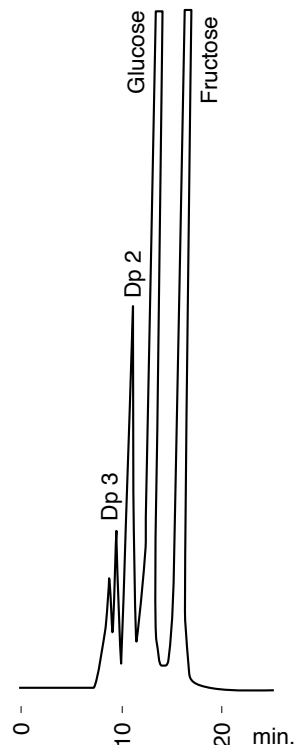

Fig. 2-7 Jam

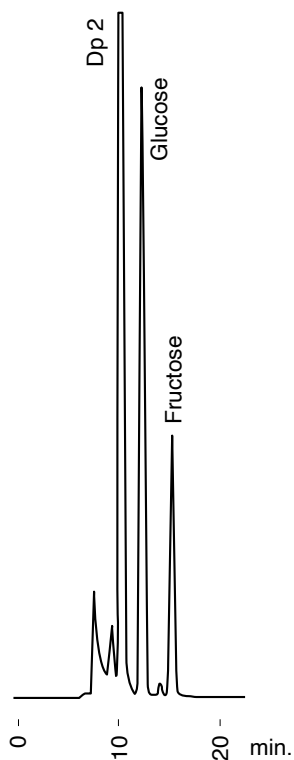
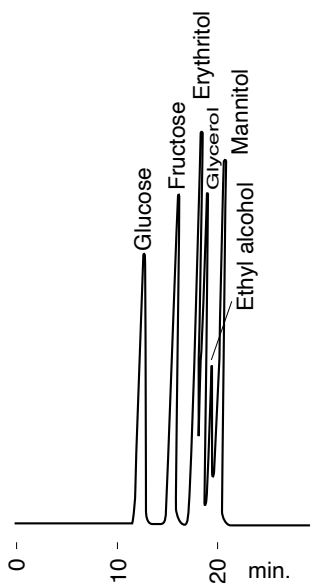

Fig. 2-8 Sugars/Alcohols



Conditions
 Column : MCI GEL™ CK08EC
 8mm I.D.×300mm
 Eluent : H₂O
 Flow rate : 0.6mL/min
 Column temp. : 75°C
 Detection : RI

Application data of CK08EC

Fig. 2-9 Sugars / Alcoles (Comparison with competitor's column)

Conditions
 Column : 7.8x 300 mmI.D. (MCI GEL™ CK08EC / Competitor's Column)
 Eluent : Milli Q water
 Flow rate : 0.6mL/min
 Temperature : 75 °C
 Sample Conc : 40mmol/ml each
 Injection : 20µL
 Detection : RI

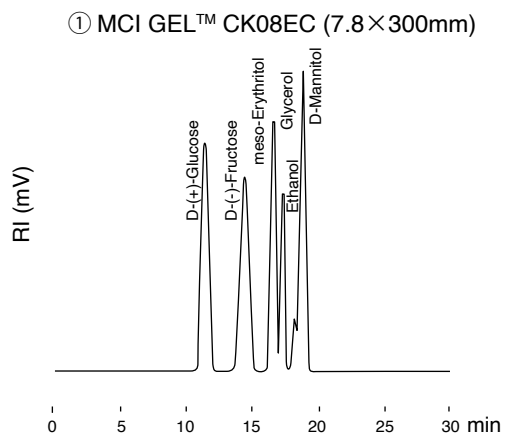

Results:	Rt	TPN	As	Rs
D-(+)-Glucose	11.39	2085	1.07	-
D-(-)-Fructose	14.39	2597	0.97	2.89
meso-Erythritol	16.59	16899	0.84	2.66
Glycerol	17.31	19051	0.95	1.40
Ethanol	18.18	37357	0.80	2.12
D-Mannitol	18.83	12885	1.00	1.33

Pressure: 28Bar (Including system pressure)

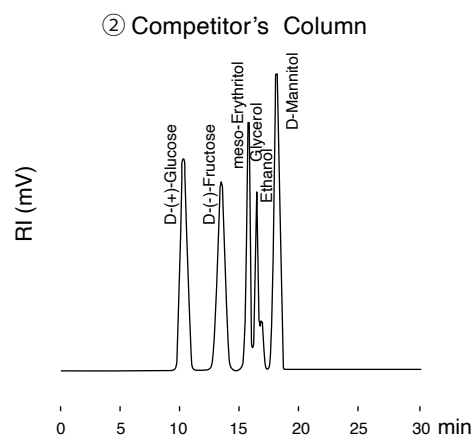

Results:	Rt	TPN	As	Rs
D-(+)-Glucose	10.25	1509	1.12	-
D-(-)-Fructose	13.37	2210	0.98	2.93
meso-Erythritol	15.63	15833	0.90	2.78
Glycerol	16.32	21608	0.95	1.50
Ethanol	16.73	35525	1.69	1.14
D-Mannitol	17.99	10387	0.96	2.43

Pressure: 38Bar (Including system pressure)

Fig. 2-10 Sugars (Comparison with competitor's column)

Conditions
 Column : 7.8x 300 mmI.D. (MCI GEL™ CK08EC / Competitor's Column)
 Eluent : Milli Q water
 Flow rate : 0.6mL/min
 Temperature : 75 °C
 Sample Conc : 40mmol/ml each
 Injection : 20µL
 Detection : RI

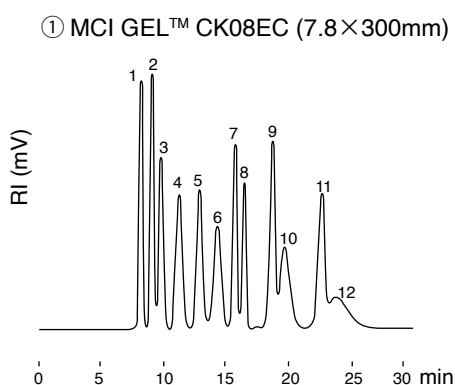

Results:	Rt	TPN	As	Rs
1 Stachyose hydrate	8.25	5111	1.04	-
2 β-Gentiobiose	9.13	5504	0.97	1.86
3 α-Lactose monohydrate	9.83	3024	1.19	1.22
4 D-(+)-Glucose	11.27	2002	1.09	1.77
5 D-(+)-Mannose	12.90	3350	1.01	1.76
6 D-(-)-Fructose	14.32	2713	1.01	1.47
7 Ribitol (Adonitol)	15.78	15410	0.84	1.85
8 meso-Erythritol	16.50	17734	0.99	1.43
9 D-Mannitol	18.73	13044	0.87	3.90
10 D-(-)-Salicin	19.69	4104	1.35	1.08
11 Xylitol	22.66	13965	0.88	3.09
12 D-(-)-Ribose	23.75	2278	2.09	0.86

Pressure: 28Bar (Including system pressure)

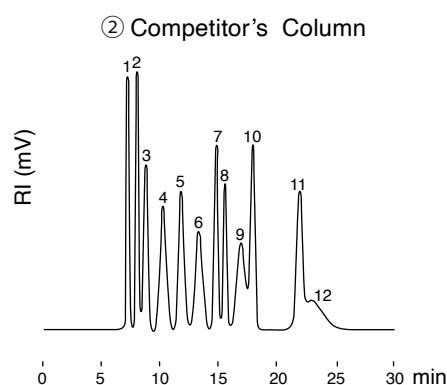

Results:	Rt	TPN	As	Rs
1 Stachyose hydrate	7.21	4243	1.07	-
2 β-Gentiobiose	8.02	4397	1.01	1.78
3 α-Lactose monohydrate	8.76	2249	1.14	1.28
4 D-(+)-Glucose	10.23	1441	1.06	1.73
5 D-(+)-Mannose	11.78	2830	1.03	1.63
6 D-(-)-Fructose	13.27	2188	1.00	1.51
7 Ribitol (Adonitol)	14.76	13744	0.92	1.86
8 meso-Erythritol	15.51	16005	1.01	1.50
9 D-(-)-Salicin	16.86	3594	0.88	1.79
10 D-Mannitol	17.88	12043	1.07	1.23
11 Xylitol	21.90	13235	0.94	5.72
12 D-(-)-Ribose	22.87	2381	3.00	0.86

Pressure: 39Bar (Including system pressure)

Application data of CK08EC

Fig. 2-11 Analysis of galactose impurity

① Galactose / Fructose = 0.1 / 99.9

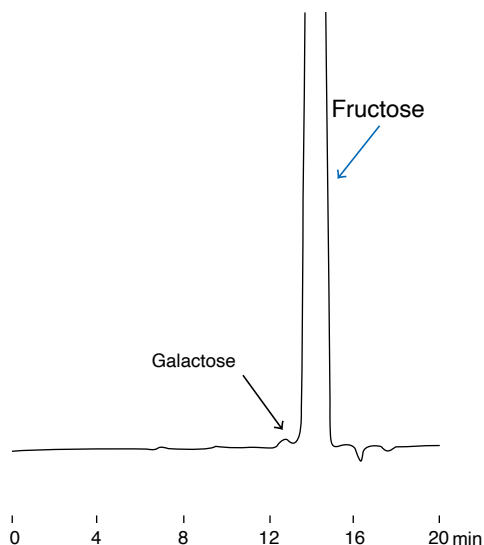

② Galactose / Sucrose = 0.1 / 99.9

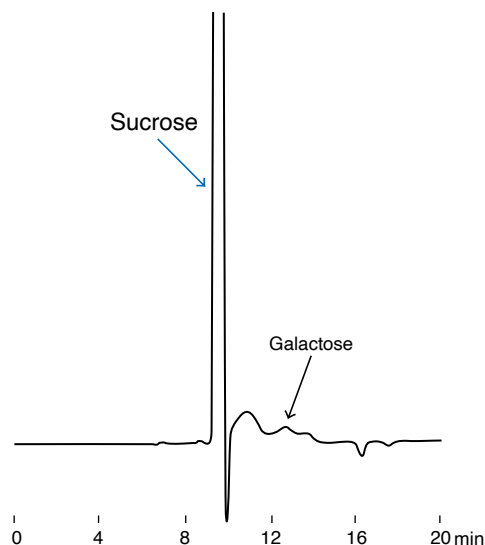

Conditions
 Column : MCI GEL™ CK08EC 7.8mm I.D.×300mm
 Eluent : Milli Q water
 Flow rate : 0.6mL/min
 Temp : 85°C
 Detection : RI

Application data of CK08E

Fig. 2-12 Maltose syrup powder

① Maltose syrup powder

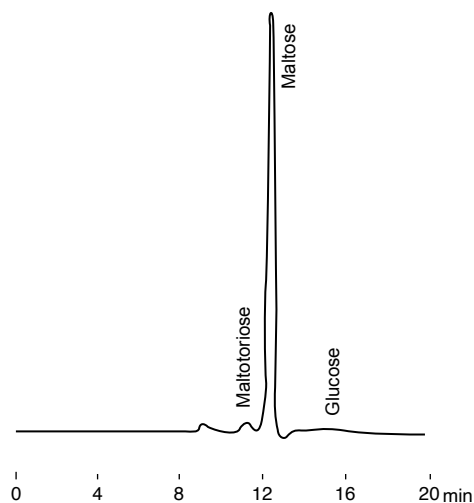

② Mixture

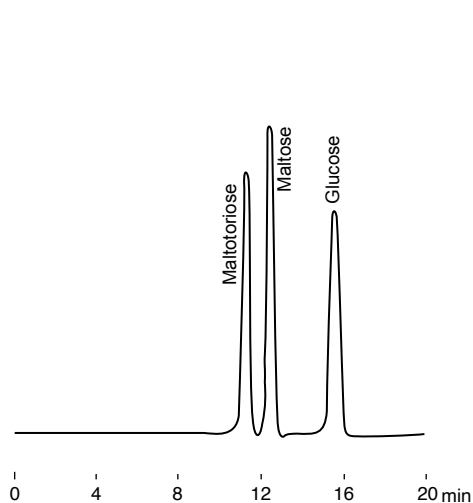

Conditions
 Column : MCI GEL™ CK08E 7.8mm I.D.×300mm
 Eluent : Milli Q water
 Flow rate : 0.4mL/min
 Temp : 50°C
 Sample : Maltotriose
 Maltose
 Glucose
 Injection : 5µl.
 Detection : RI

Application data of CK08EH

Fig. 2-13 Carboxylic acids

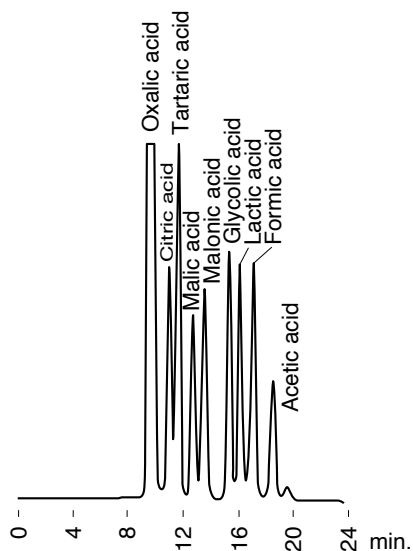
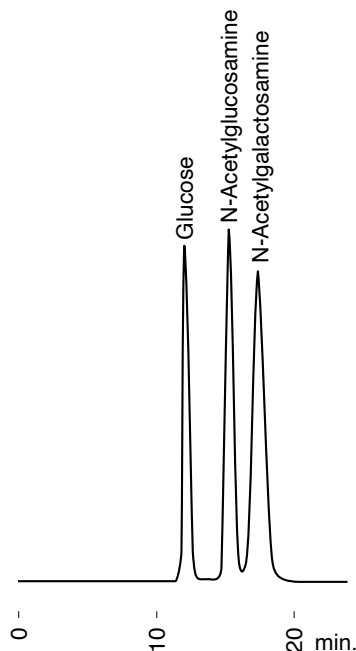
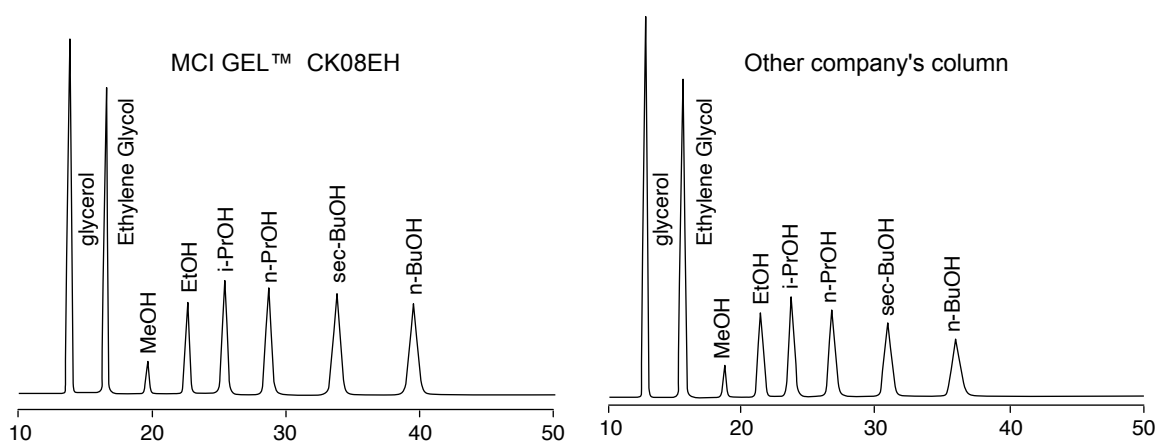

Fig. 2-14 Amino sugars



Conditions
 Column : MCI GEL™ CK08EH, 8mm I.D.×300mm
 Eluent : 1% H₃PO₄ (Fig.2-13,2-14)
 Flow rate : 0.6mL/min
 Column temp.: 45°C (Fig. 2-13), ambient (Fig. 2-14)
 Detection : 210nm (Fig. 2-13), RI (Fig. 2-14)

Fig. 2-15 Alcohols



Conditions
 Column : MCI GEL™ CK08EH, 7.8mm I.D.×300mm
 Eluent : 1% H₃PO₄
 Temp : 60 °C
 Press : 2.5 bar
 Detection : RI
 Injection : 10.0 μL

Application data of CK08EH

Fig. 2-16 Chloroacetic acids

Conditions
 Column : MCI GEL™ CK08EH
 8mm I.D.×300mm
 Eluent : 1% H₃PO₄
 Flow rate : 0.6mL/min
 Column temp. : 45°C
 Detection : 210nm

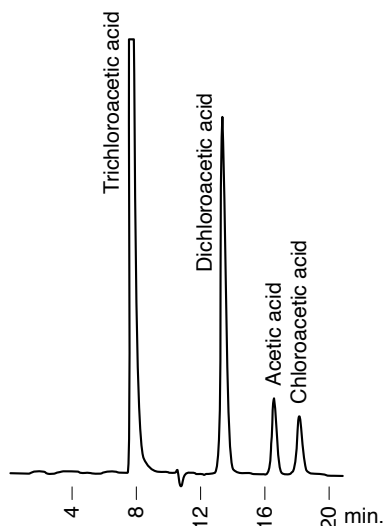

Fig. 2-17 Poly alcohols

Conditions
 Column : MCI GEL™ CK08EH
 8mm I.D.×300mm
 Eluent : 1% H₃PO₄
 Flow rate : 0.6mL/min
 Column temp. : 25°C
 Detection : RI

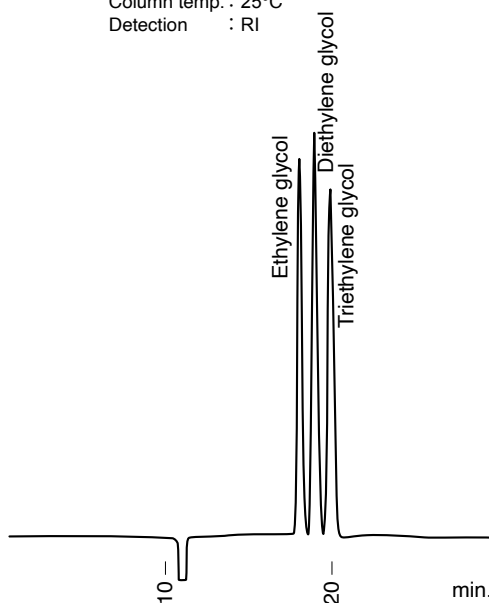
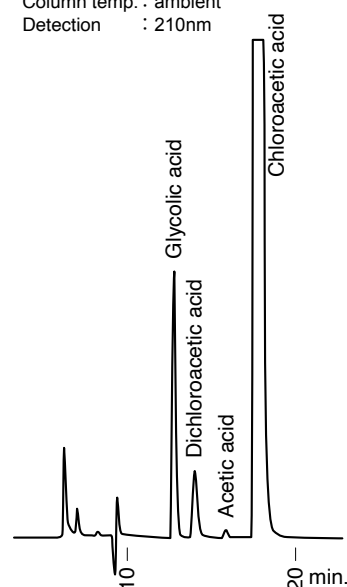

Fig. 2-18 Carboxylic acids

Conditions
 Column : MCI GEL™ CK08EH
 8mm I.D.×300mm
 Eluent : 2% H₃PO₄
 Flow rate : 0.6mL/min
 Column temp. : ambient
 Detection : 210nm



Application data of CK06SC

Fig. 2-19 Lactose

Conditions
 Column : MCI GEL™ CK06SC
 8mm I.D.×500mm
 Eluent : H₂O
 Flow rate : 1.0mL/min
 Column temp. : 75°C
 Detection : RI
 Injection volume : 20μL

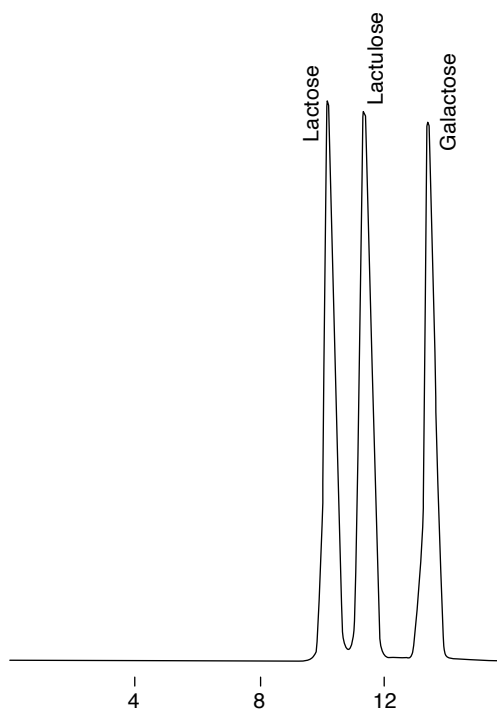

● Peak retention time for Sugars and Sugar alcohols on various columns [min]

CK08EC Ca ²⁺		CK08E Na ⁺	
Stachyose	9	Stachyose	8
Melezitose		Melezitose	
Raffinose		Raffinose	
Gentiobiose	10	Gentiobiose	9
Cellobiose		Cellobiose	
Trehalose		Trehalose	
Isomaltose		Sucrose	
Sucrose		Isomaltose	
Maltose		Melibiose	
Melibiose		Maltose	
Lactose		Maltulose	
Maltulose	11	Lactose	10
Lactulose	12	Lactulose	11
Glucose	13		
Xylose	14	Glucose	12
Galactose		Mannitol	
Mannose		Rhamnose	
Rhamnose	15	Adonitol	
Fructose	16	Sorbitol	13
Fucose		Digitoxose	
Inositol		Mannose	
Arabinose		Xylose	
Digitoxose		Galactose	
Adonitol	17	Fructose	14
Erythritol	18	Inositol	
Mannitol	20	Xylitol	
Salicin	22	Fucose	
Dulcitol	23	Dulcitol	
Xylitol	24	Arabinose	
Sorbitol	24	Erythritol	15
Ribose	25	Ribose	17
		Salicin	27

Column temp : CK08EC...75°C, CK08E...45°C
 Column size : 8mm I.D.×300mm
 Eluent : H₂O
 Flow rate : 0.6mL/min
 Sample : 1% aq. solution
 Injection vol. : 20μL

* ; These sugars, containing Fructose component, may partially be decomposed by CK08EH.

CK04S, CK04SS CK02A, CK02AS

Cation exchange columns
applications; oligosaccharides

The separation mechanism is based on gel filtration chromatography and elution is achieved via simple distilled water. A larger molecule elutes ahead.



CK02A 20×250



CK04S 10×200



CK04SS 10×200

● Separation ability of each column

MCI GEL™ column	Counter ion	Separation ability (degree of polymerization)	USP
MCI GEL™ CK04S	Na ⁺	8~9	L58
MCI GEL™ CK04SS	Ag ⁺	12~13	
MCI GEL™ CK02A	Na ⁺	15~16	L58
MCI GEL™ CK02AS	Ag ⁺	19~20	

Calibration curves of malto-oligosaccharides

Fig. 2-20

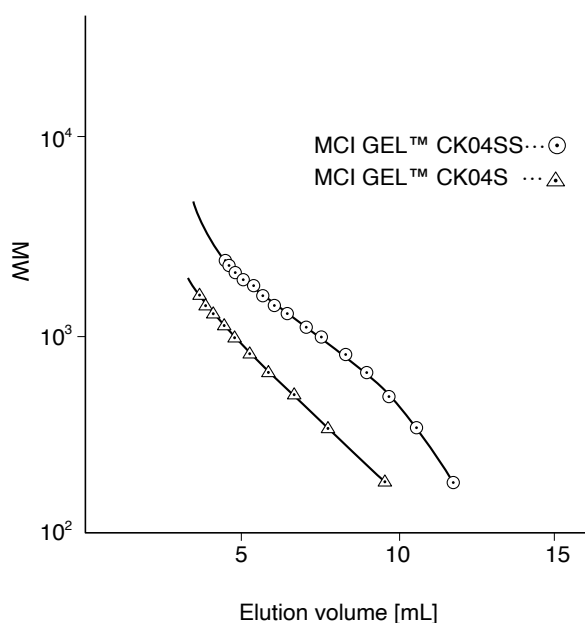
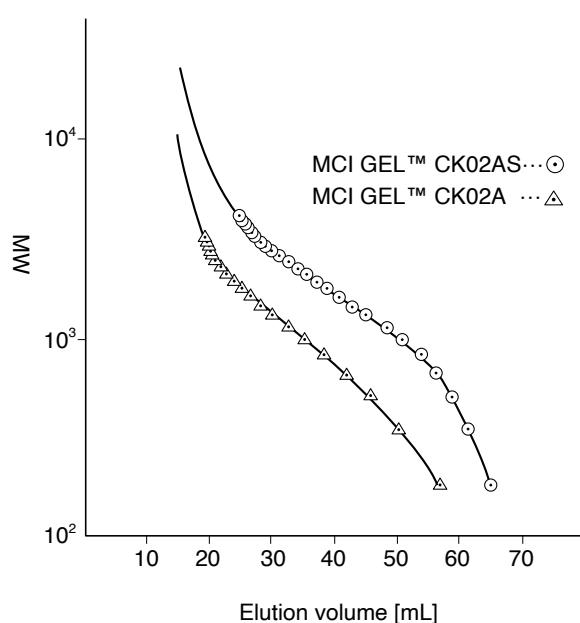

Fig. 2-21



Comparison data of malto-oligosaccharides

Fig. 2-22 MCI GEL™ CK04S
10mm I.D.×200mm

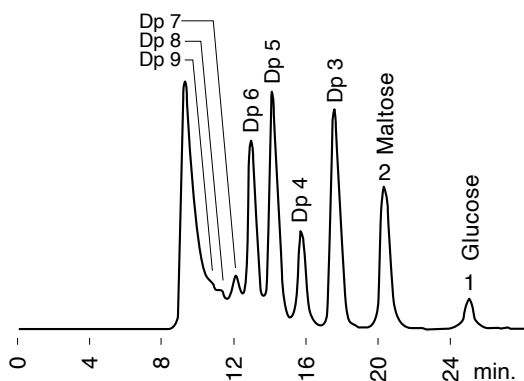

Fig. 2-23 MCI GEL™ CK04SS
10mm I.D.×200mm

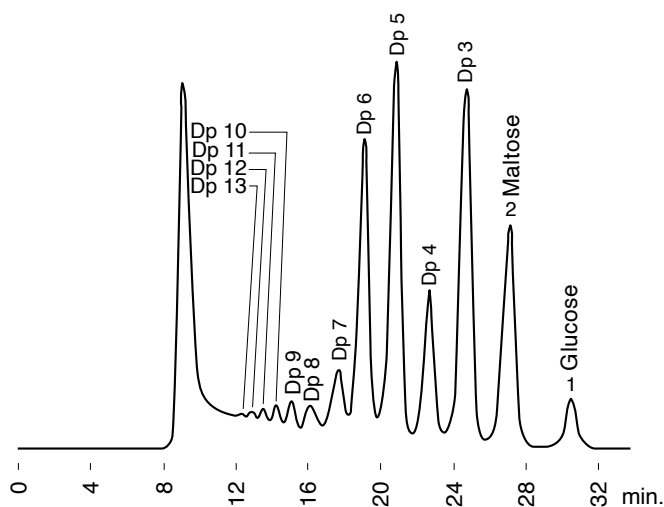

Fig. 2-24 MCI GEL™ CK02A
20mm I.D.×250mm

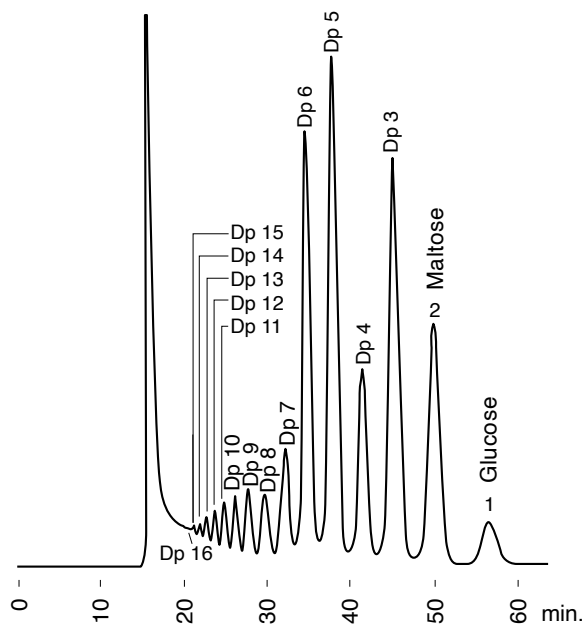
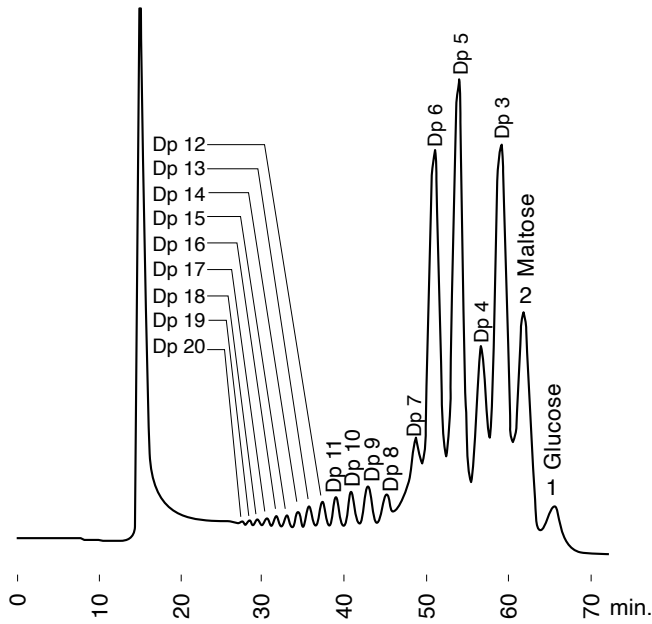

Fig. 2-25 MCI GEL™ CK02AS
20mm I.D.×250mm



Conditions
 Eluent : H₂O
 Flow rate : 0.4mL/min (Fig. 2-22, 2-23, 2-26, 2-27)
 1.0mL/min (Fig. 2-24, 2-25, 2-28)
 Column temp. : 85°C
 Detection : RI

Comparison data of authentic malto-oligosaccharides samples

Fig. 2-26 MCI GEL™ CK04S
10mm I.D.×200mm

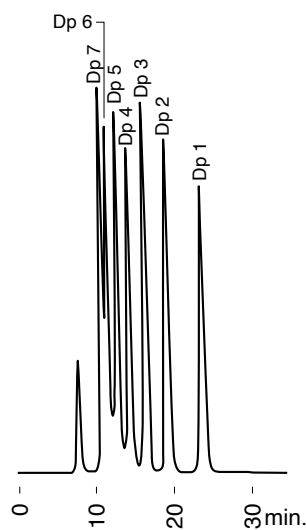

Fig. 2-27 MCI GEL™ CK04SS
10mm I.D.×200mm

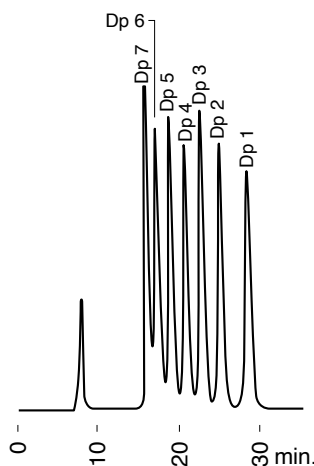
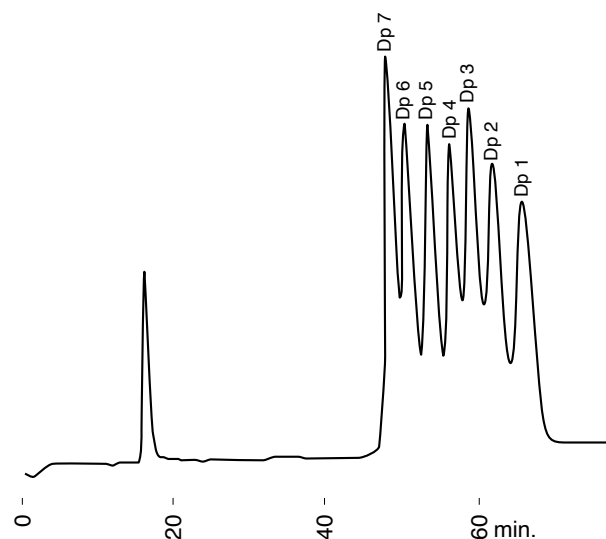

Fig. 2-28 MCI GEL™ CK02AS
20mm I.D.×250mm



Application data of CK04S

Fig. 2-29 Honey

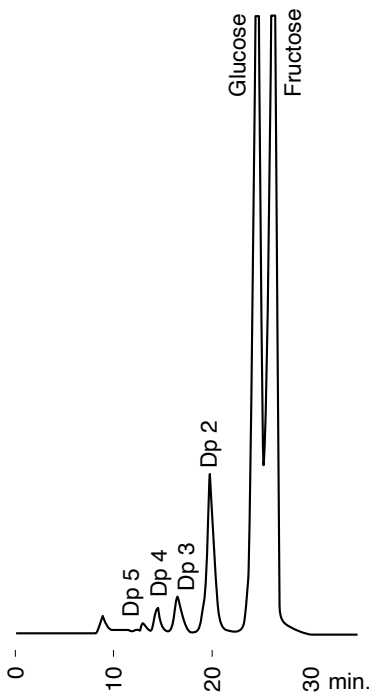

Fig. 2-30 Jam

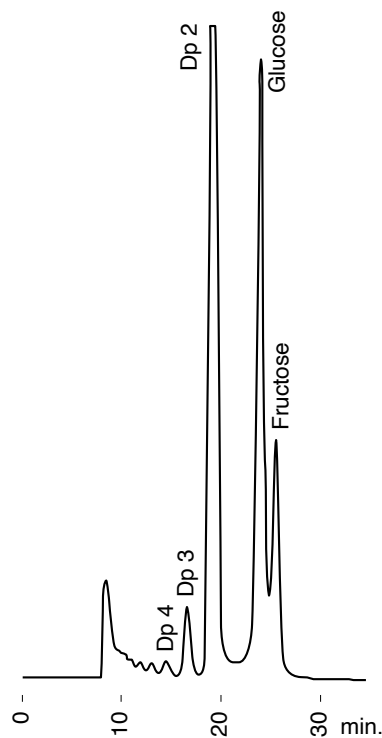
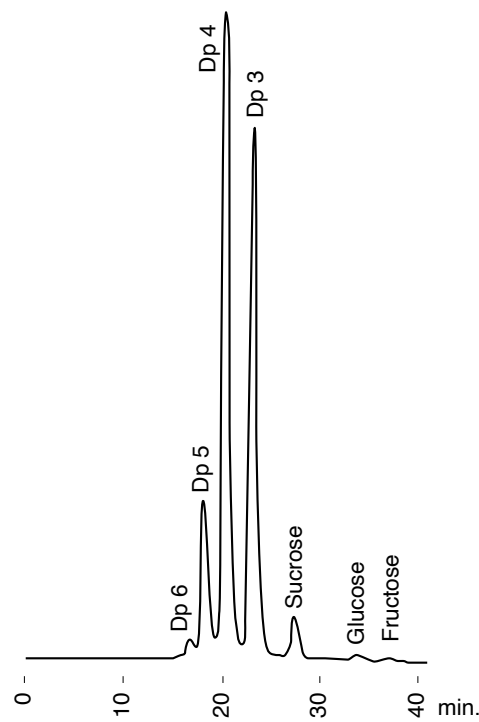

Fig. 2-31 Fructo-oligosaccharides



Conditions
 Column : MCI GEL™ CK04S
 10mm I.D.×200mm
 Eluent : H₂O
 Flow rate : 0.4mL/min (Fig. 2-29, 2-30) 0.3mL/min (Fig. 2-31)
 Column temp. : 85°C (Fig. 2-29, 2-30) 45°C (Fig. 2-31)
 Detection : RI



CK10U 6×120

Separation of amino acids

Fig. 2-32 Protein hydrolyzates amino acids

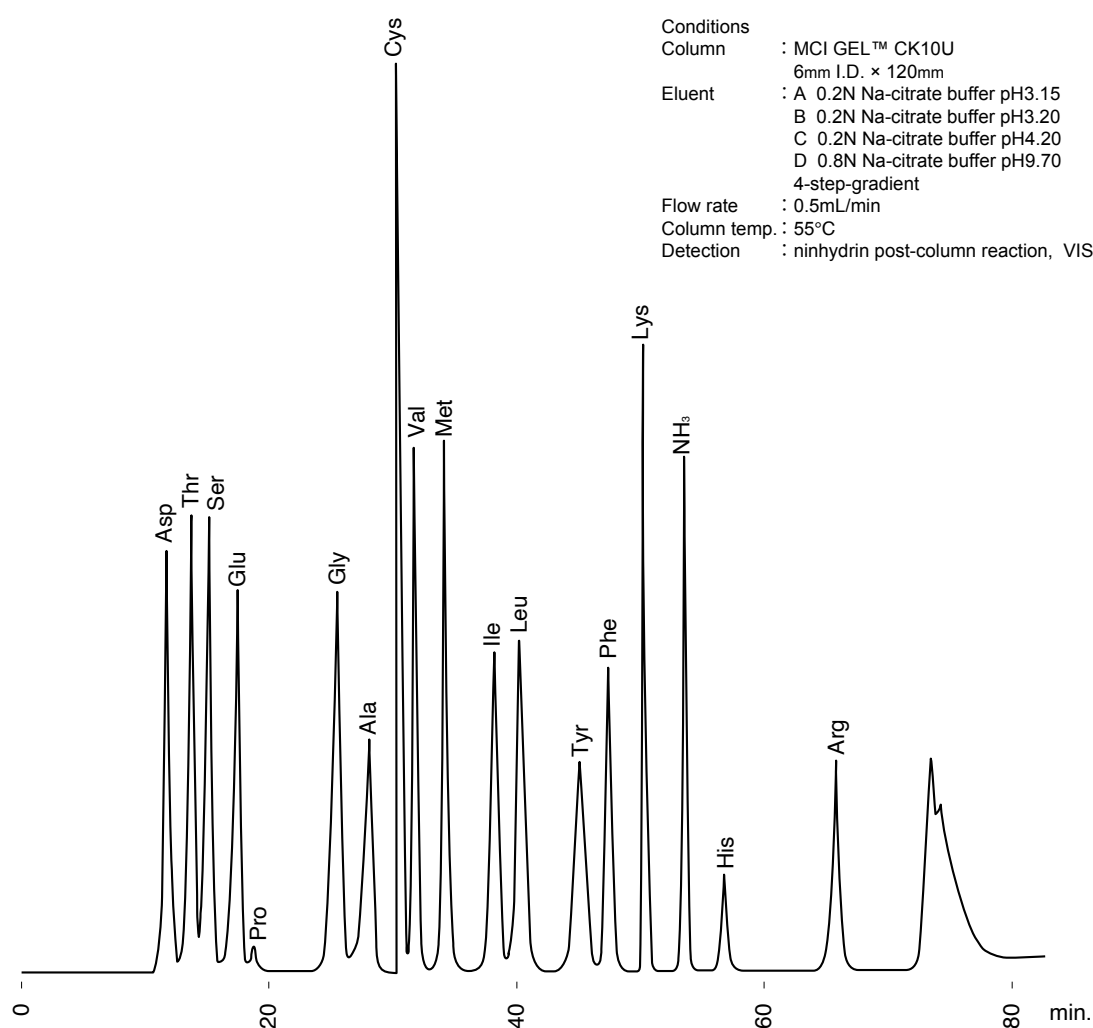

As for analysis of amino acids by a cation exchange column such as MCI GEL™ CK10U, MCI GEL™ AFR2-PC is recommended as a pre-column. The AFR2-PC column is very effective to stabilize base line because ammonium in eluent is trapped in this column. The ammonium ion may disturb base line stability. The AFR2-PC should be installed between an outlet of HPLC pump and an inlet of sample injector. A gradient elution, commonly used for amino acid analysis, is influenced by HPLC instrument. So to obtain a satisfactory chromatogram, gradient conditions should be optimized in accordance with the HPLC equipment.

Separation of amino acids

Fig. 2-33 Valine, β -Alanine

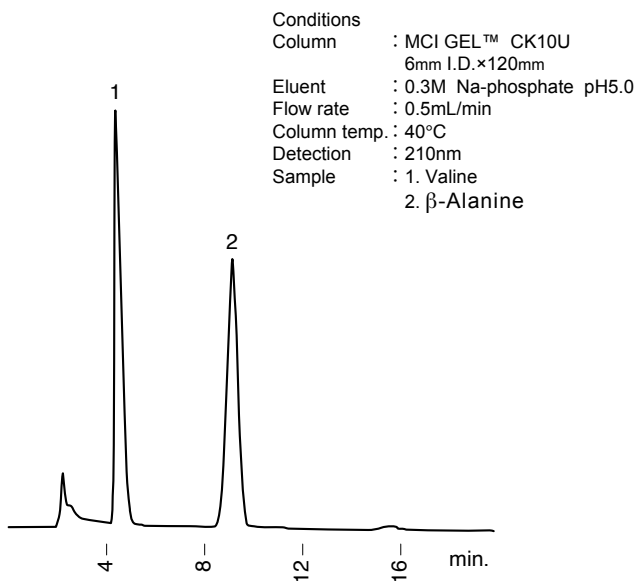

Fig. 2-34 γ -Aminobutyric acid

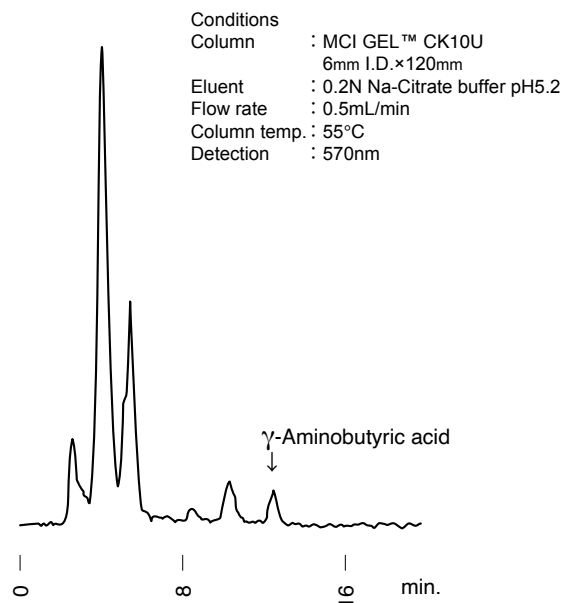

Fig. 2-35 cyclic amino acids

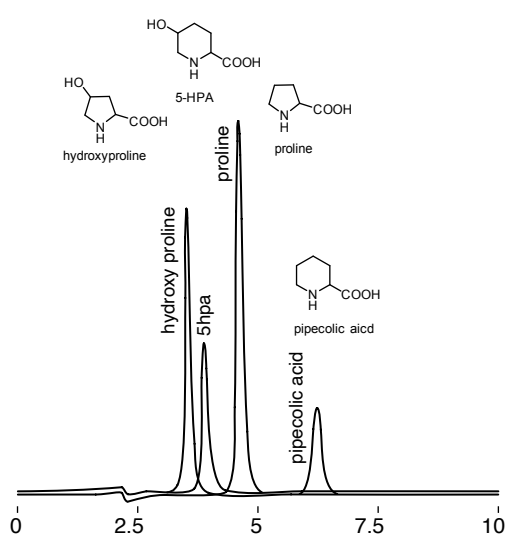

Fig. 2-36 alkyl amino acid

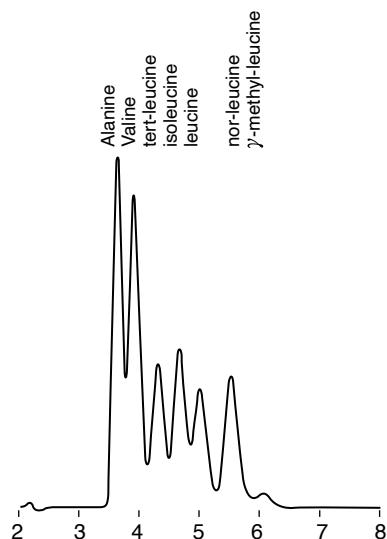
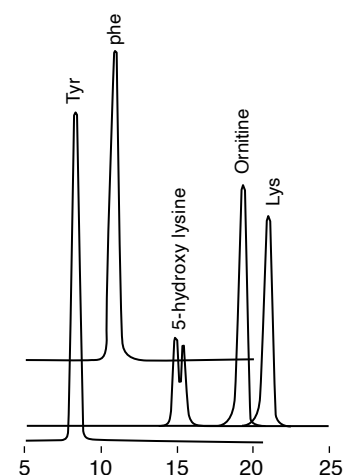

Fig. 2-37 basic amino acid and aromatic amino acids



Conditions
 Column : MCI GEL™ CK10U
 6mm I.D.×120mm
 Eluent : 0.3M NaSO₄ (pH5.7)
 Flow : 0.5mL/min
 Temp. : 60°C
 Detection : UV210nm

MCI GEL™ CA08F packed column has been designed for the analysis of nucleotides, sugars, and organic acids by anion exchange chromatography mode.

This column will provide excellent separation and short analysis time.

Application data of CA08F

Fig. 2-38 Sugars

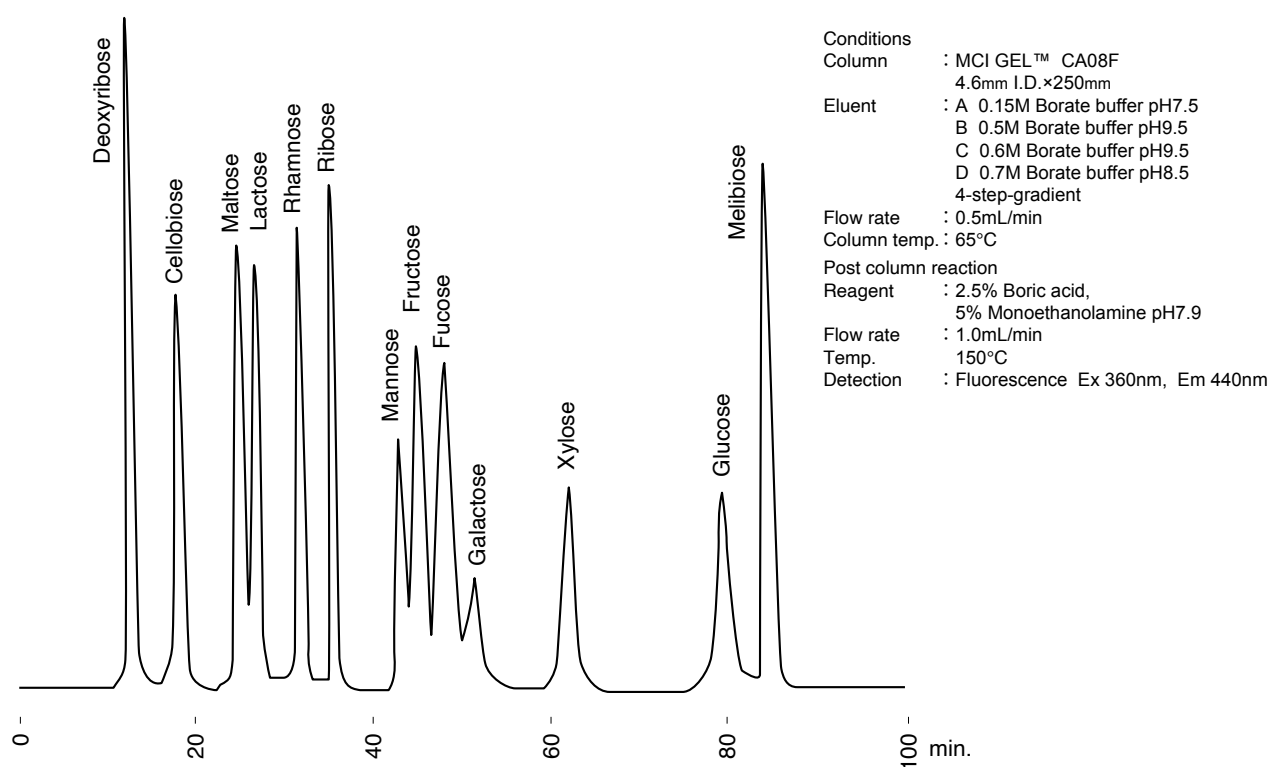
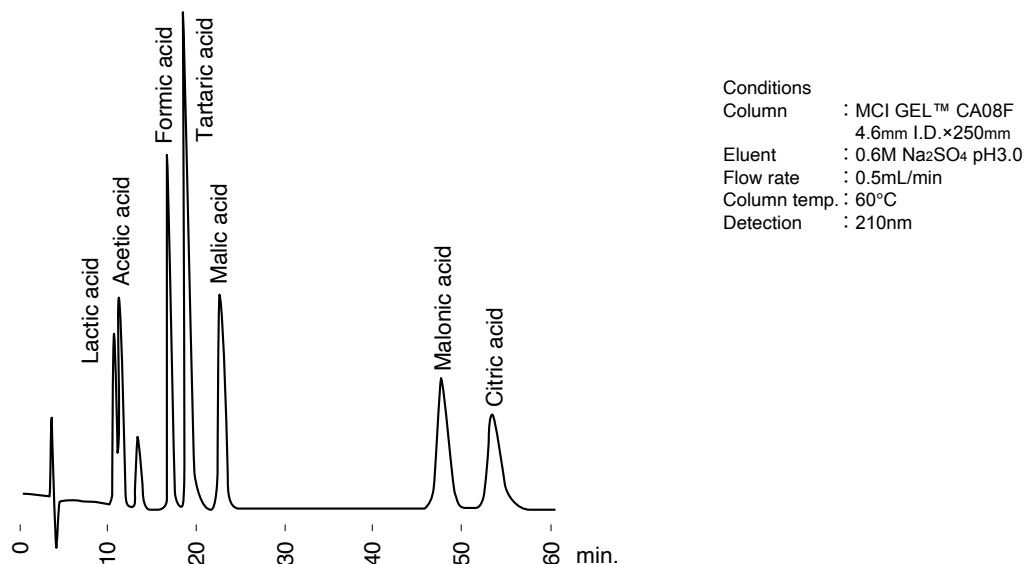

Fig. 2-39 Carboxylic acids



Application data of CA08F

Fig. 2-40 Carboxylic acids

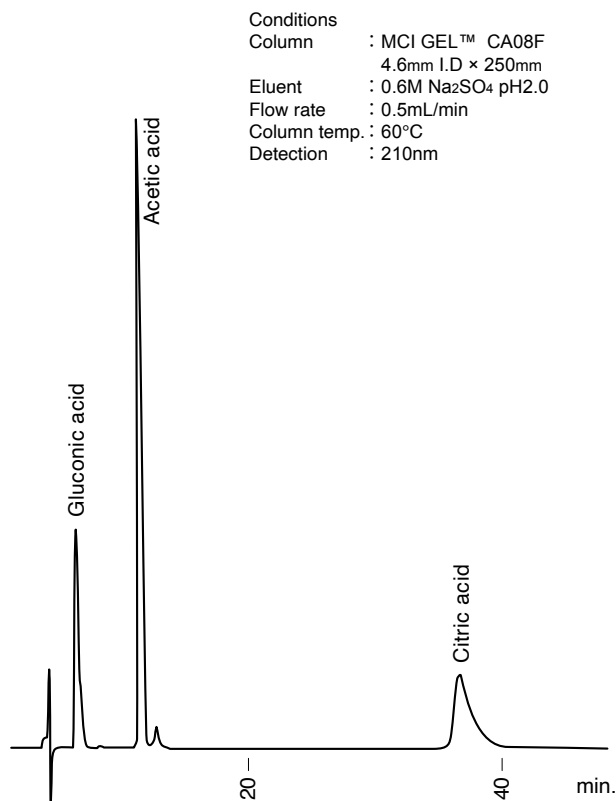

Fig. 2-41 Organic acid

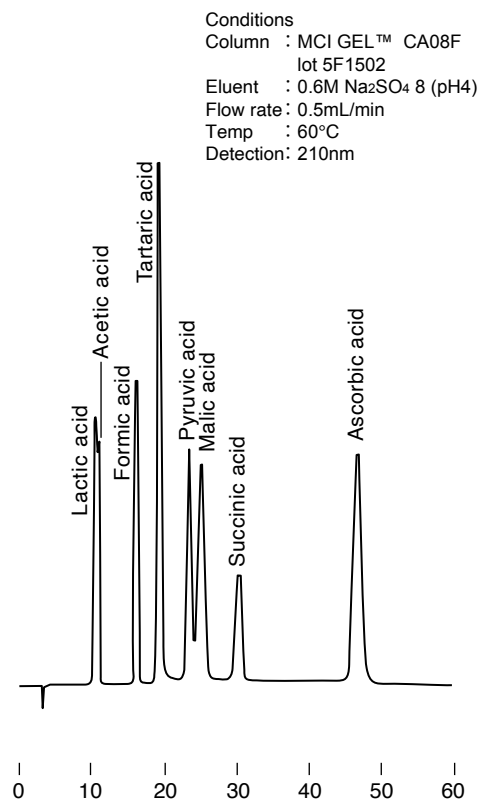
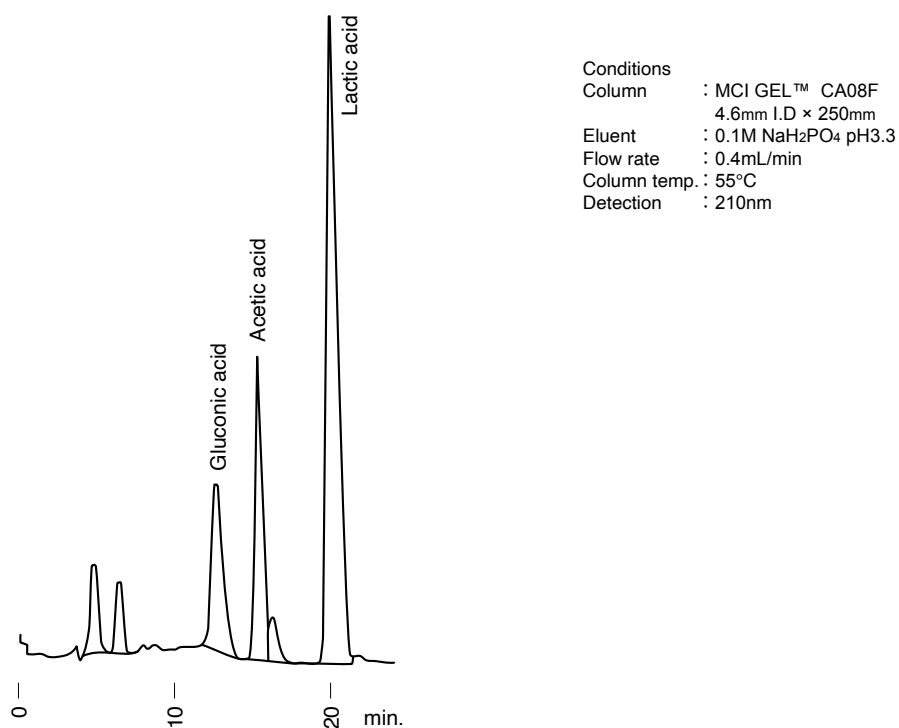

Fig. 2-42 Carboxylic acids



- Cation chromatography column MCI GEL™ SCK01
- Cation chromatography column MCI GEL™ CHK45/C05
- Anion chromatography column MCI GEL™ SCA04

The MCI GEL™ ion chromatography columns are based on surface functionalized cation and anion exchange resins designed for non-suppressed ion chromatography applications. The non-suppressed ion chromatography is an analysis technique of cations and anions with combination of a packed column of low capacity ion exchange resin and low concentration of electrolyte solution as an eluent. The advantage of the ion chromatography is that several ions can be analyzed by only one injection with free of complicated sample pre-treatment.

Cation chromatography column MCI GEL™ SCK01

Packing material of MCI GEL™ SCK01 is crosslinked polystyrene functionalized with sulfonic acid. This column is characterized by excellent resolution and rapid analysis for monovalent and divalent cations. Standard monovalent cations like Li⁺, Na⁺, NH₄⁺, K⁺, Rb⁺, Cs⁺ and simple amines such as mono-, di- and trimethylamine can be resolved using a nitric acid solution as eluent. Divalent cations, such as alkaline earth metals and transition metal elements, can be efficiently resolved using tartaric acid and complexing reagent such as ethylene diamine to selectively elute the metals from the column.

■ Note:

When using the MCI GEL™ SCK01 column for monovalent cations, it is recommended that a pre-column, MCI GEL™ SCK-PC, be used to trap heavy metals which might otherwise poison the SCK01 column resulting in a rapid loss of capacity and chromatographic performance.

Cation chromatography Column MCI GEL™ CHK45/C05

Packing material of MCI GEL™ CHK45/C05 is made of crosslinked polymethacrylate functionalized with carboxylic acid. By use of simple eluent system, MCI GEL™ CHK45/C05 can separate both monovalent and divalent cations in tap water, river water and other environmental water samples.

Anion chromatography column MCI GEL™ SCA04

Packing material of MCI GEL™ SCA04 is based on a hydrophilic vinyl polymer matrix functionalized with quaternary ammonium group and particle size of 5 μm. A solution of potassium hydrogen phthalate and a vanilic acid (VA)/N-methyldiethanolamine (MDEA) solution both can be used as a mobile phase. The unique VA/MDEA eluent, is developed for the SCA04 column, which allows users to determine 7 standard anions in 14 minutes without system peak.

■ Note:

A pre-column, MCI GEL™ SCA-PC is recommended for prevention of contamination to the SCA04 column when the VA/MDEA eluent is used. The SCA-PC is effectively prolong SCA04 column life. The SCA-PC should be installed between an outlet of HPLC pump and an sample injector.



SCA04 4.6 × 150 PEEK

Column list

Cation analysis	MCI GEL™ SCK01	6mm I.D×50mm	Stainless steel column
Cation analysis	MCI GEL™ SCK01	4.6mm I.D×150mm	Stainless steel column
Pre-column for cation analysis	MCI GEL™ SCK-PC	6mm I.D×50mm	Stainless steel column
Cation analysis	MCI GEL™ CHK45/C05	4.6mm I.D×150mm	Stainless steel column
Anion analysis	MCI GEL™ SCA04	4.6mm I.D×150mm	PEEK column
Pre-column for anion analysis	MCI GEL™ SCA-PC	8mm I.D×10mm	Stainless steel column

*USP L31 column

Application data of SCK01

Fig. 3-1 Monovalent cations

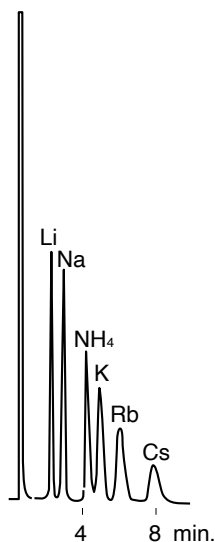

Fig. 3-2 Amines

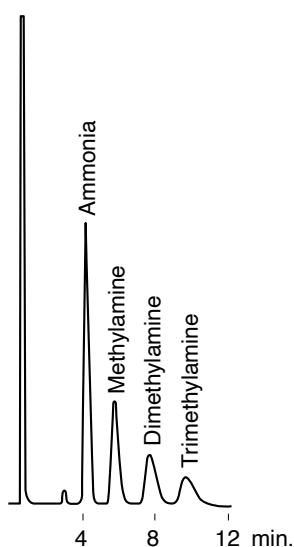

Fig. 3-3 Monovalent cations in rain

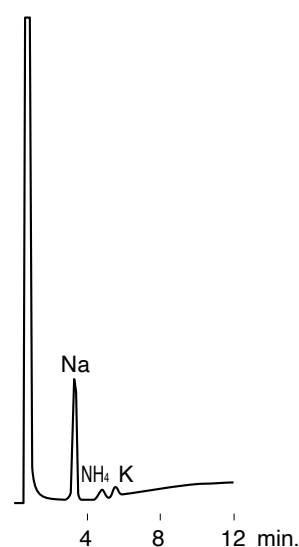

Fig. 3-4 Monovalent cations in tap water

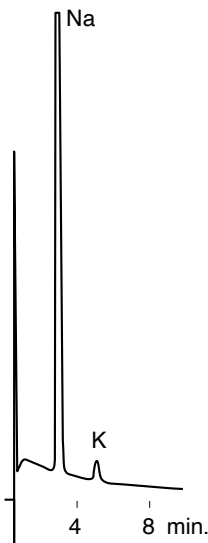

Fig. 3-5 Sports drink

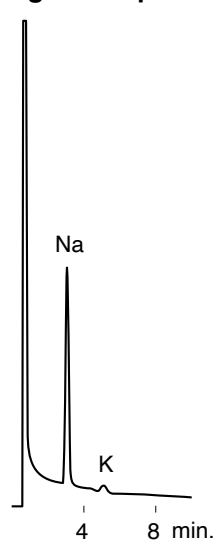
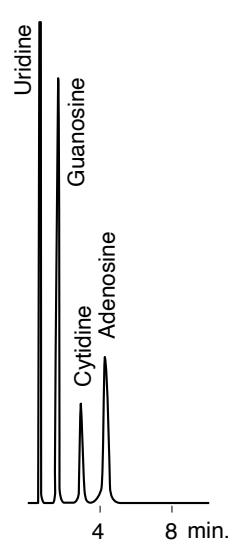

Fig. 3-6 Nucleoside



Conditions
 Column : MCI GEL™ SCK01 6mm I.D.×50mm
 Eluent : 5mM HNO₃
 Flow rate : 1.0mL/min
 Column temp. : 40°C
 Detection : Conductivity (Fig. 3-1, 3-2, 3-3, 3-4, 3-5) 254nm (Fig. 3-6)

Application data of SCK01

Fig. 3-7 Alkaline earth metals

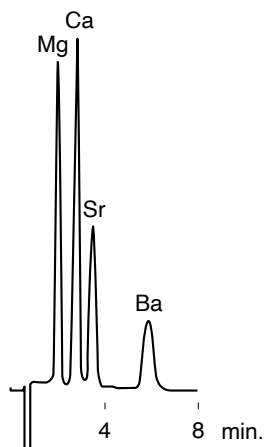

Fig. 3-8 Transition metals

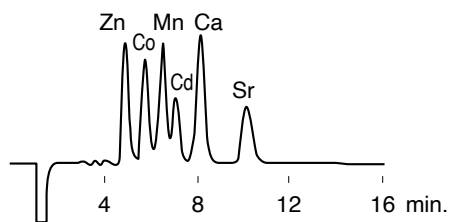
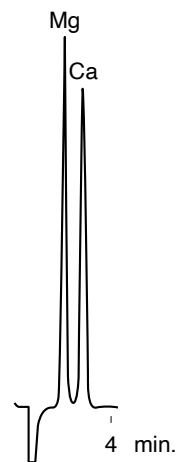

Fig. 3-9 Divalent cations



Conditions
 Column : MCI GEL™ SCK01, 6mm I.D. x50mm(Two columns are connected in series in Fig. 3-8)
 Eluent : 2mM Tartaric acid / 1.5mM Ethylenediamine (Fig. 3-7, Fig. 3-9)
 1.5mM Tartaric acid / 0.8mM Ethylenediamine(Fig. 3-8)
 Flow rate : 1.0 mL/min
 Temp. : 40°C
 Detection : Conductivity

Application data of CHK45/C05

Fig. 3-10 Mono, Divalent cations

Conditions
 Column : MCI GEL™ CHK45/C05 (SUS)
 4.6mm I.D. x150mm
 Eluent : 4mM H₂SO₄
 Flow rate : 1.2mL/min
 Temp. : 40°C
 Detection : Conductivity
 Sample inj : 100μL
 Li (0.5ppm), Na (1ppm), NH₄ (1ppm), K (4ppm), Mg (4ppm), Ca (4ppm)

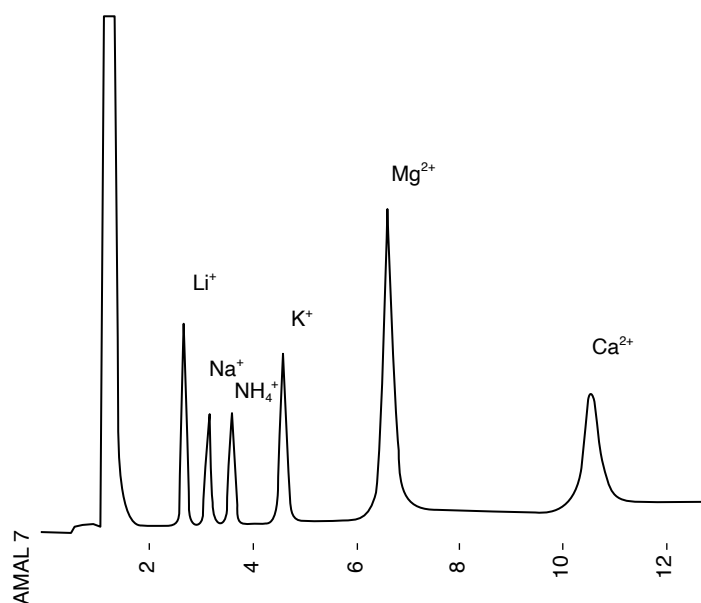

(Data provided by Professor Yokoyama of Yokohama National University)

Application data of SCA04

Fig. 3-11 Standard anions
eluent ; VA/MDEA

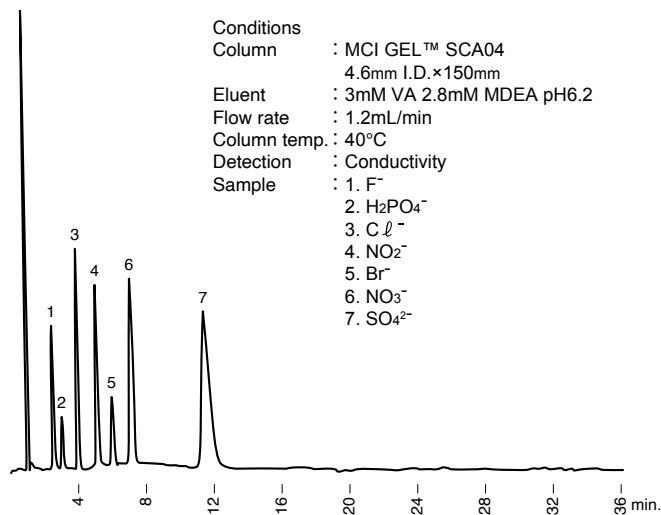

Fig. 3-12 Standard anions
eluent ; Potassium hydrogenphthalate

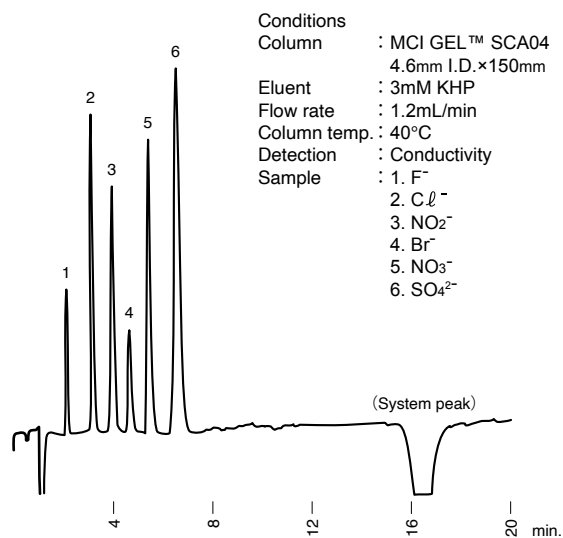
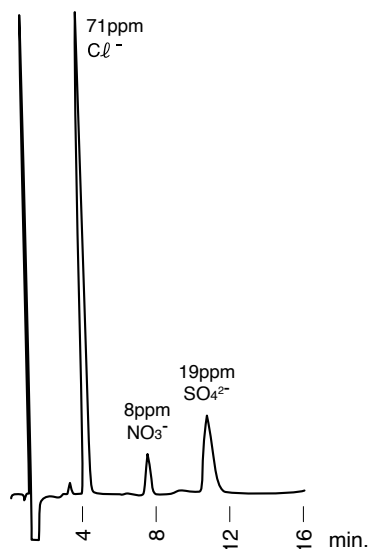
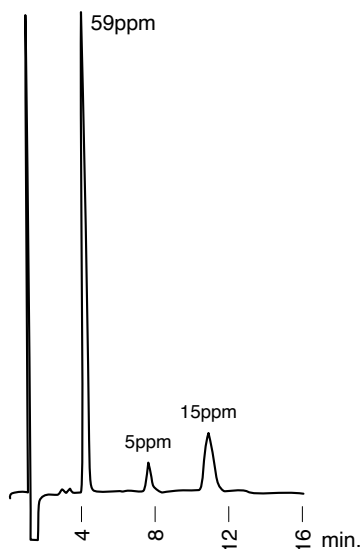

Fig. 3-13 Rain

A; Beginning of rain fall



B; After 4 hours



C; After 38 hours

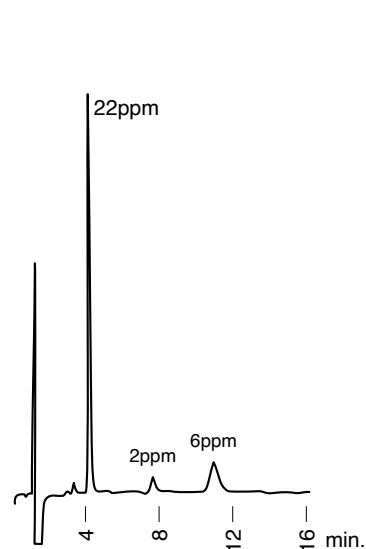

Application data of SCA04

Fig. 3-14 River water

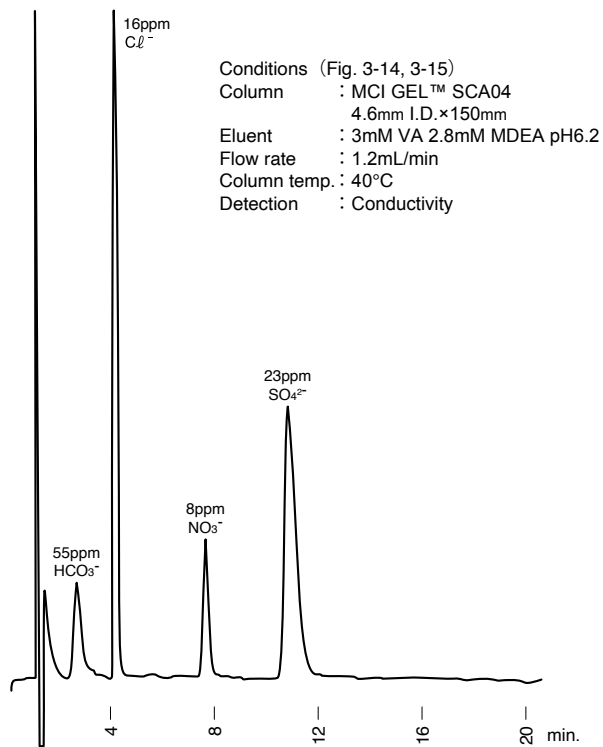

Fig. 3-15 Sulfur compounds

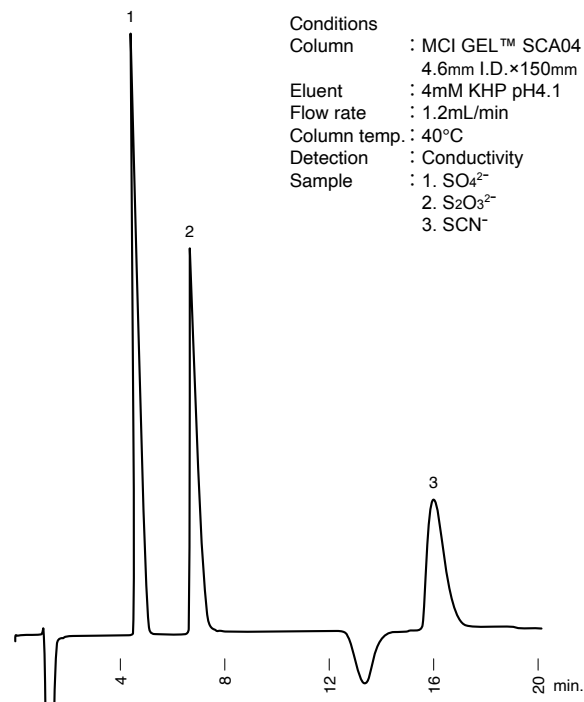
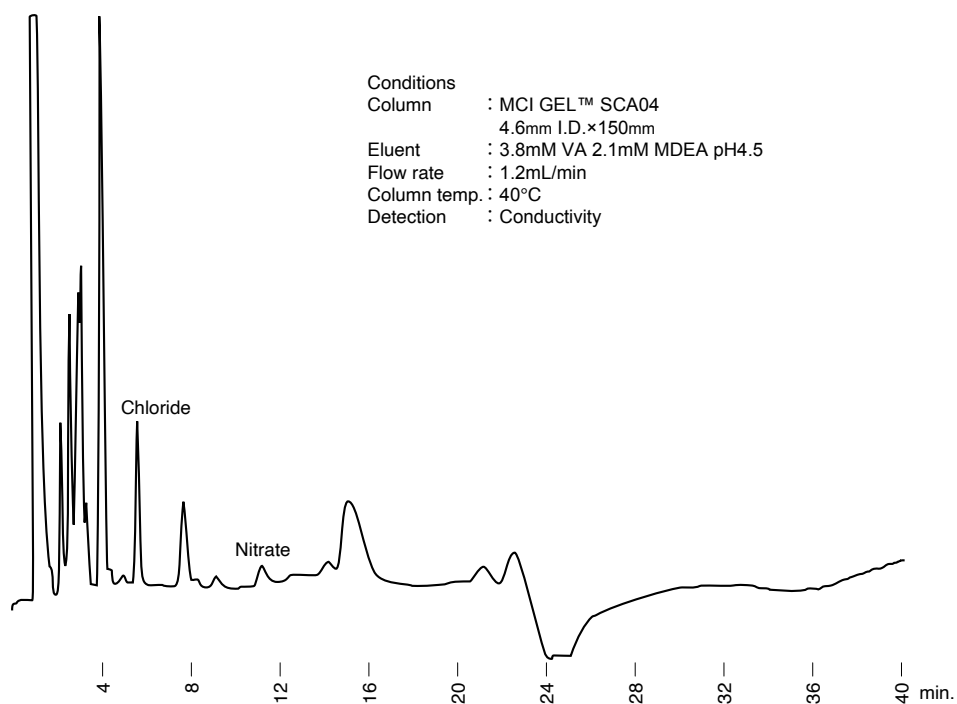

Fig. 3-16 Instant coffee



Column selection guide
 1
 Ion exchange columns and materials
 2
 Ion chromatography columns and materials
 3
 Bioseparation columns and materials
 4
 Analytical and preparative chromatography columns and materials for pharmaceutical applications
 5
 Critical separation columns
 6
 SPE sorbent series
 7
 MCI GEL™ column list
 8
 MCI GEL™ material list
 9
 Compounds index
 10

- Ion-exchange chromatography columns
XtalSpeed™ series
- Size-exclusion chromatography columns
MCI GEL™ CQP series

Bioseparation columns

MCI GEL™ bioseparation columns are based on a hydrophilic, wide-pore, and rigid polymer designed for analytical chromatography of proteins, peptides, enzymes, and other biomolecules.

MCI GEL™ CQP series are used for size-exclusion chromatography.

XtalSpeed™ series are ion-exchange columns used for protein purification. High-quality target proteins are obtained with this column at a high recovery rate. XtalSpeed™ series are used for both analytical and preparative purpose in protein crystallography and NMR research.

XtalSpeed™ series are also used for antibody variant analysis and protein isoform analysis.

Column name	USP	Separation mode	Functional Group
XtalSpeed™ SP01	—	Cation exchange	Sulfopropyl(SP)
XtalSpeed™ DA01	—	Anion exchange	Diethyl amino ethyl(DEAE)
MCI GEL™ CQP06	L25	Size exclusion	—
MCI GEL™ CQP10	L38	Size exclusion	—
MCI GEL™ CQP30	L37, L38	Size exclusion	—



XtalSpeed™ series Ion exchange chromatography columns

Ion exchange chromatography columns

XtalSpeed™ series columns are ion-exchange columns used for protein purification. They have been designed especially for protein crystallography and NMR research, and enable to purify target proteins with high quality at a high recovery rate and in a very short time and obtain protein crystals for further analysis.

We developed hydrophilic and chemically stable polymer layers based on highly porous polymer beads, reducing non-specific binding to the lowest level.

To eliminate other interactions and allow target proteins participate only in the ion-exchange mechanism, this column was able to separate similar proteins that other columns never succeeded to separate.

Even under large sample loading, this column maintains excellent selectivity. Taking these aspects into consideration, XtalSpeed™ series can be used as preparative columns for protein.

XtalSpeed™ SP01 is also used for antibody variant analysis.

Column list

Column name	Column size	Code	Housing	Functional Group
SP01	Φ4.6mm×50mm	0-047-11	PEEK	Sulfopropyl (SP)
	Φ4.6mm×100mm	0-047-12		
	Φ7.5mm×100mm	0-047-13		
	Φ11.5mm×100mm	0-047-14		
DA01	Φ4.6mm×50mm	0-047-01	PEEK	Diethylaminoethyl (DEAE)
	Φ4.6mm×100mm	0-047-04		
	Φ7.5mm×100mm	0-047-02		
	Φ11.5mm×100mm	0-047-03		

Application data of XtalSpeed™ series

Fig. 4-1 Analysis of Rituximab

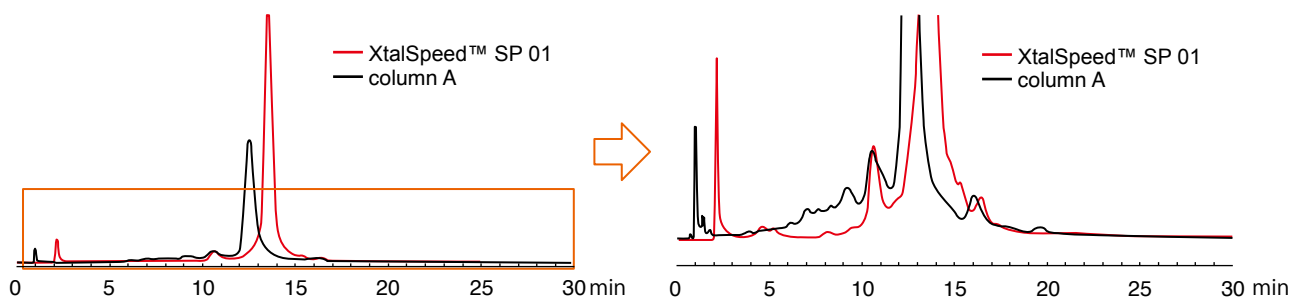

Conditions
 Column : XtalSpeed™ SP01
 100 x 4.6mmI.D
 Column A (250 x 4mmI.D)
 Eluent : A, 20mM Na phosphate (pH7.0)
 B, A + 1.0M NaCl
 Flow rate : 0.529mL/min for XtalSpeed and 1.0mL/min for ProPac
 Gradient : (A), 2.5-20.0%B over 30min + 20.0-100%B over 5min
 (C), 2.5-5.0%B over 30min + 5.0-100%B over 5min

Fig. 4-2 Analysis of Hemoglobin A1C

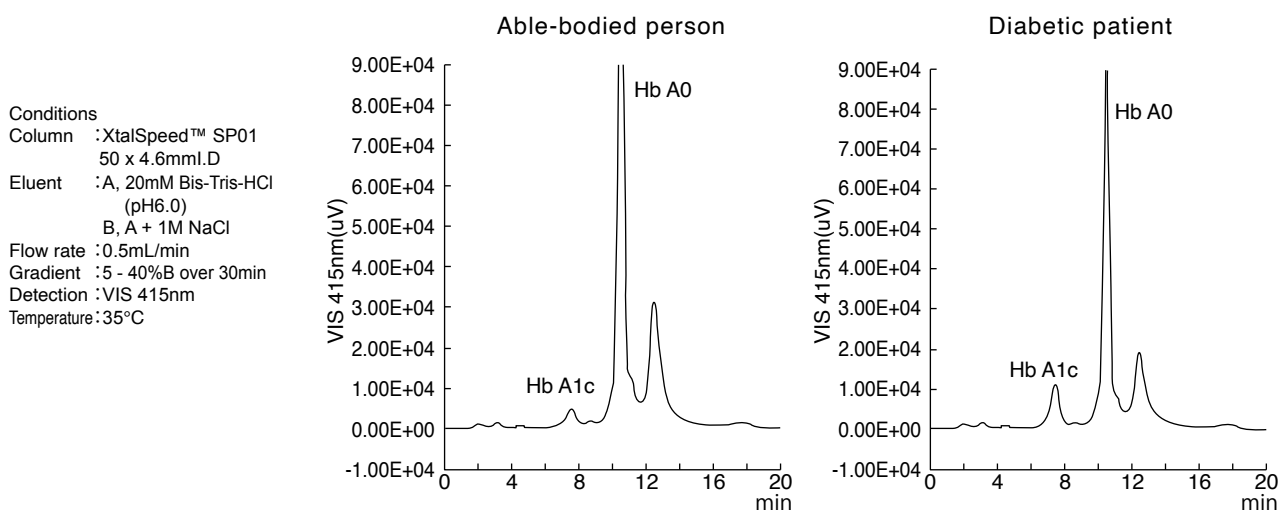

Conditions
 Column : XtalSpeed™ SP01
 50 x 4.6mmI.D
 Eluent : A, 20mM Bis-Tris-HCl
 (pH6.0)
 B, A + 1M NaCl
 Flow rate : 0.5mL/min
 Gradient : 5 - 40%B over 30min
 Detection : VIS 415nm
 Temperature : 35°C

Fig. 4-3 Comparison of loadability

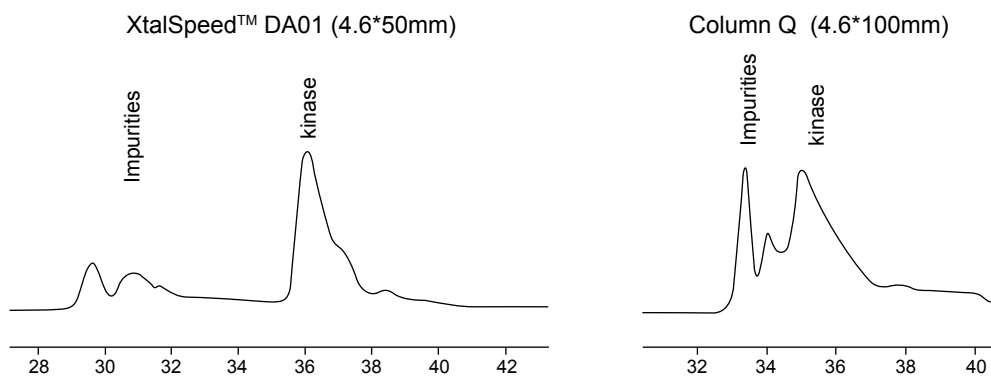

Conditions
 Eluent : Buffer A:50mM HEPES-NaOH(pH7)
 Buffer B:50mM HEPES-NaOH(pH7),1M NaCl
 Flow rate : XtalSpeed™ DA01 :0.6mL/min
 Competitor's Column Q:1mL/min
 Gradient : 0-40%B (0-400mM NaCl)/40CV
 Sample : 50 micro grams of human kinase

- Column selection guide 1
- Ion exchange columns and materials 2
- Ion chromatography columns and materials 3
- Bioseparation columns and materials 4
- Analytical and preparative chromatography columns and materials for pharmaceutical applications 5
- Critical separation columns 6
- SPE sorbent series 7
- MCI GEL™ column list 8
- MCI GEL™ material list 9
- Compounds index 10

Size exclusion chromatography columns

Size exclusion chromatography is a liquid chromatographic technique which separates solute molecules according to their size in solution. The column is packed with porous particles and separation takes place as a result of the differential solute distribution outside and within the pores of the packing material. Solute molecules which are larger than the pores of the packing material will be excluded and therefore will elute first and have a lower retention time than the smaller one. The CQP series columns based on a hydrophilic polymer are designed for analysis of water soluble polymers such as oligosaccharides and PEG, etc.

Column list

● CQP series

MCI GEL™ column	USP	Column dimensions	Packing materials		Theoretical plates number [TP/column]	Exclusion limit [PEG]
			Particle size [μm]	Pore size [nm]		
MCI GEL™ CQP06	L25	7.5mm I.D. ×600mm	10	12	10000	~1×10 ³
MCI GEL™ CQP10	L38	7.5mm I.D. ×600mm	10	20	6000	~1×10 ⁴
MCI GEL™ CQP30	L37, L38	7.5mm I.D. ×600mm	10	60	6000	~1×10 ⁶

● Guard columns

MCI GEL™ column	Column dimensions
MCI GEL™ CQP06G	4.0mm I.D.×50mm
MCI GEL™ CQP10G	4.0mm I.D.×50mm
MCI GEL™ CQP30G	4.0mm I.D.×50mm

Application data of CQP series

Fig. 4-4 Calibration curve

Conditions
 Column : MCI GEL™ CQP06
 MCI GEL™ CQP10
 MCI GEL™ CQP30
 7.5mm I.D.×600mm
 Eluent : H₂O
 Flow rate : 1.0mL/min
 Column temp. : ambient
 Detection : RI
 Sample : PEG 100μl inj.

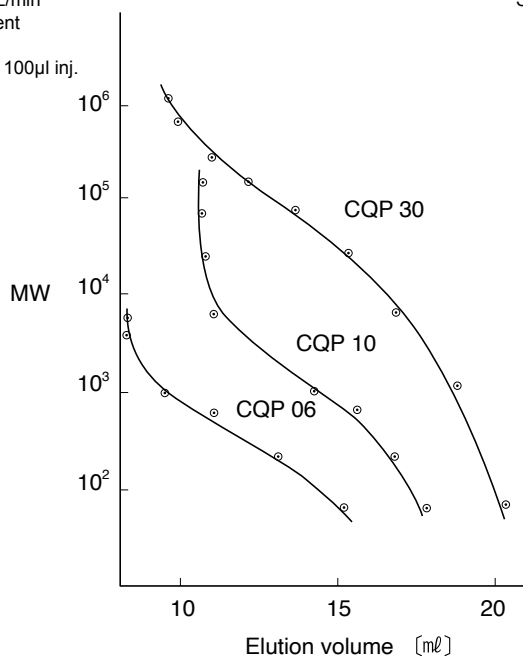

Fig. 4-5 Separation of PEG mixture

Conditions
 Column : MCI GEL™ CQP30 7.5mm I.D.×600mm
 Eluent : H₂O
 Flow rate : 1.0mL/min
 Column temp. : 25°C
 Detection : RI
 Sample : 1. PEG 145,000
 2. 40,000
 3. 6,000

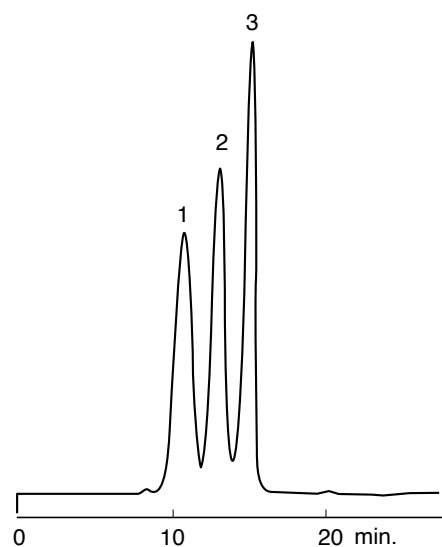

Fig. 4-6 Separation of protein mixture

Conditions
 Column : MCI GEL™ CQP30 7.5mm I.D.×600mm
 Eluent : 14mM Tris-HClO₄ buffer
 Flow rate : 1.0mL/min
 Column temp. : ambient
 Detection : 280nm
 Sample : 1. Ferritin (MW440,000)
 2. Ovalbumin (MW43,000)
 3. Myoglobin (MW17,500)
 4. Cytochrome c (MW12,400)

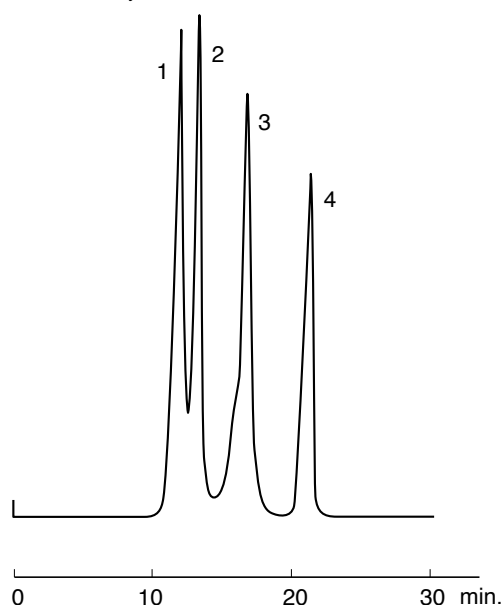
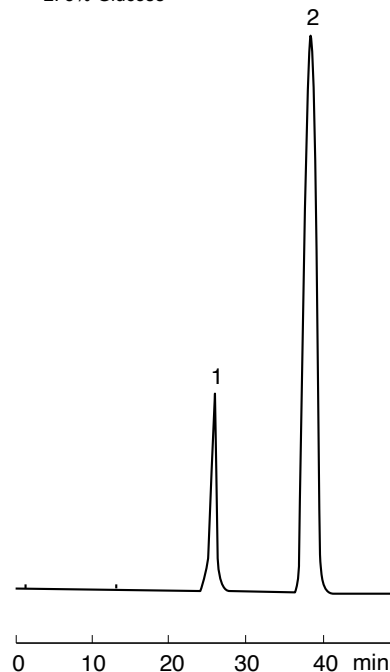

Fig. 4-7 Separation of gluconic acid and glucose

Conditions
 Column : MCI GEL™ CQP06 7.5mm I.D.×600mm
 Eluent : H₂O
 Flow rate : 0.8mL/min
 Column temp. : ambient
 Detection : RI
 Sample : 1. 5% Gluconic acid
 2. 5% Glucose



○ Polymeric partition chromatography columns and materials MCI GEL™ CHP series

Separation mechanism of CHP series

High performance liquid chromatography relies on one of the following physical phenomena for efficient separation of solutes: partition, adsorption, size exclusion, or ion exchange. Of these, partition chromatography is the most commonly used method, and it separates solutes based on their difference in partitioning between a stationary phase and a mobile phase. This technique has currently become the mainstay in industry for the separation of organic compounds such as pharmaceuticals, agricultural chemicals, and other intermediates. Practically, partition chromatography can be performed in two different modes depending on the relative polarities of the stationary and mobile phases. In the normal phase (NP) mode, the mobile phase is less polar than the stationary phase while the situation is reversed in the reverse phase (RP) mode, where the mobile phase is significantly more polar than the stationary phase.

MCI GEL™ specializes in polymer-based packing materials. The use of polymer-based columns has become more widespread thanks to the many advantages of the polymer matrix like excellent selectivity, the absence of specific adsorption which is found commonly with silica-based packing, operability in a wide pH range and good chemical stability due to the inert nature of polymeric materials. The MCI GEL™ partition chromatography columns are based on a polystyrene and polymethacrylate porous polymer. As RP columns, they are applied to the separation of a wide variety of organic compounds, both in the isocratic and gradient elution mode. The compounds include peptides, insulin, small molecule APIs, nutraceutical compounds, water-soluble vitamins and nucleotides. As NP columns, they are used in the separation of various carotenoids, fat-soluble vitamins, steroids, and food additives. These columns tolerate various organic solvents like hexane, heptane, methylene chloride, and alcohols.

As NP columns, they are used in the separation of various carotenoids, fat-soluble vitamins, steroids, and food additives. Various organic solvents like Hexane Heptane, methylene chloride and alcohols can be used.

The MCI GEL™ packing materials are based on the same chemistries offered in the Diaion™ and Sepabeads™ synthetic adsorbent resins. These polymer chemistries, like Diaion™ HP series and Sepabeads™ SP series, are widely used and documented in the biopharmaceutical industry for fermentation extraction, the food industry and in industrial chromatographic separations. The MCI GEL™ packing materials are available as packed columns for analytical applications, and as bulk packing materials for analytical, preparative and production chromatography applications.

● Description of MCI GEL™ columns and materials

MCI GEL™ CHP20/C04

Matrix type

Particle size

{ C=Column
P=Material

MCI GEL™ CHP series are suitable for RP and NP chromatography. There are four kinds of columns of various hydrophobicities; porous polystyrene, modified porous polystyrene, polymethacrylate, and modified porous polymethacrylate. This range of packing materials offers tremendous scope for a proper selection of columns based on the properties of the target compounds.

Polystyrene packing: MCI GEL™ CHP20/C04, CHP20/C10

Modified polystyrene packing: MCI GEL™ CHP07/C04, CHP07/C10, CHK40/C04

Polymethacrylate packing: MCI GEL™ CMG20/C10

Modified polymethacrylate packing: MCI GEL™ CHPOD/C04, CHK45/C05

The hydrophobicities of the columns are in the following orders:

MCI GEL™ CHP07/C04, C10 > CHP20/C04, C10 > CHPOD/C04 ≥ ODS columns ≥ CMG20/C04, C10

Polymer columns for HPLC, with their superior chemical resistance, can be used with various mobile phases of broad pH range, acidic through alkaline. They have the following advantages due to their high hydrophobicities:

- 1) In reverse phase chromatographic methods to separate acidic or alkaline compounds, eluents that can suppress the ionic properties of such compounds are generally used. Polymer columns can be applied in these cases where ODS columns would be unsuitable.
- 2) Some extremely hydrophilic compounds, e.g., oligosaccharides, can be separated using strongly hydrophobic CHP07/C04 or CHP07/C10 columns.
- 3) Polymer columns can be washed with acidic and/or basic solutions in case of contamination.

Polymethacrylate columns, CMG20/C04 and CMG20/C10, can be applied both for reverse phase and normal phase chromatography.

Modified polystyrene packing, CHK40/C04, is a mixed-mode type material; both hydrophobic and hydrophilic interactions occur between the packing material surface and the analytes. This material is useful for compounds that are difficult to separate using existing ODS or other polymer-based columns. This column is also used in the normal phase mode and shows a unique separation profile.

All polymeric columns exhibit superior stability and yield in comparison to ODS columns, which may have free silanol groups even when end-capping agents have been used.

Column list

● CHP column series

Matrix Type	Functional group	Product name	Particle size [μm]	Column size [mm I.D.×mm]	pH range	USP
Styrene Divinylbenzene	None	CHP20/C04	4	4.6×150 20×150	Full range	L21
		CHP20/C10	10	4.6×150 4.6×250 10×250 20×150 20×250		
	Br	CHP07/C04	4	4.6×150 20×200		
		CHP07/C10	10	4.6×150 4.6×250 10×150 20×150 20×250		
	Cation exchange group	CHK40/C04	4	4.6×150		
Methacrylates	None	CMG20/C04	4	4.6×150 20×150	2~12	
		CMG20/C10	10	4.6×150 4.6×250 10×250 20×150 20×250		
	C18	CHPOD/C04	4	4.6×150 20×200		
	Weak cation exchange group	CHK45/C05	5	4.6×150		

*CHP20/C04, CHP20/C10: USP classification is L21

Retentiveness in reverse phase mode

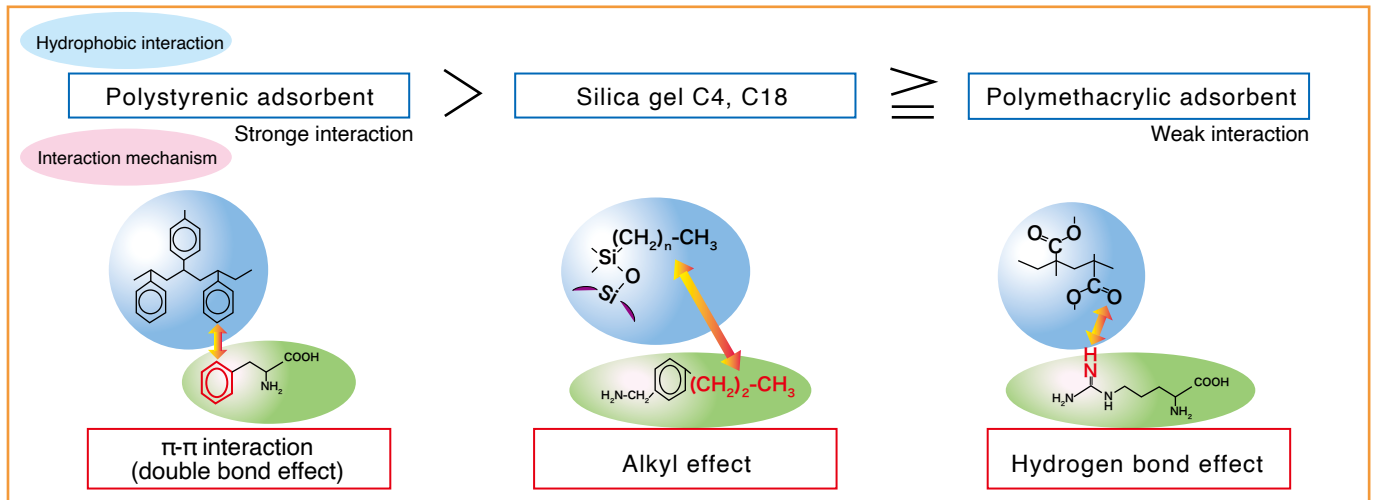

Hydrophobic interaction Interaction mechanism

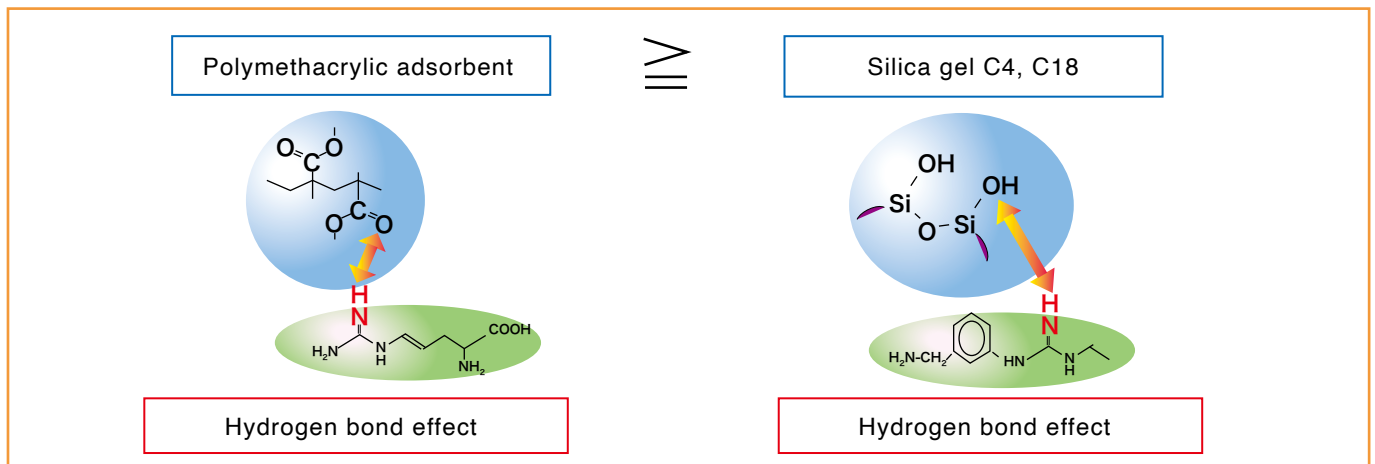

Durability of polymeric column

The polymeric RP columns are chemically stable. Specifically, the columns have resistance to an alkaline eluent. The following graphs demonstrate stability of the polymeric columns. After feeding a solution of pH 12 into the MCI GEL™ CHP20/C04, there is no change of column performance.

Fig. 5-1 Column durability at pH12 comparison between CHP20/C04 and an ODS column

Conditions
 Column : MCI GEL™ CHP20/C04 4.6mm.I.D × 150mm
 Eluent : 20mM Na₂HPO₄ pH12/CH₃CN/=60/40
 Flow rate : 0.4mL/min
 Column temp.: 25°C
 Detection : 254nm
 Sample : 1000ppm Dimethyl phthalate 5μL

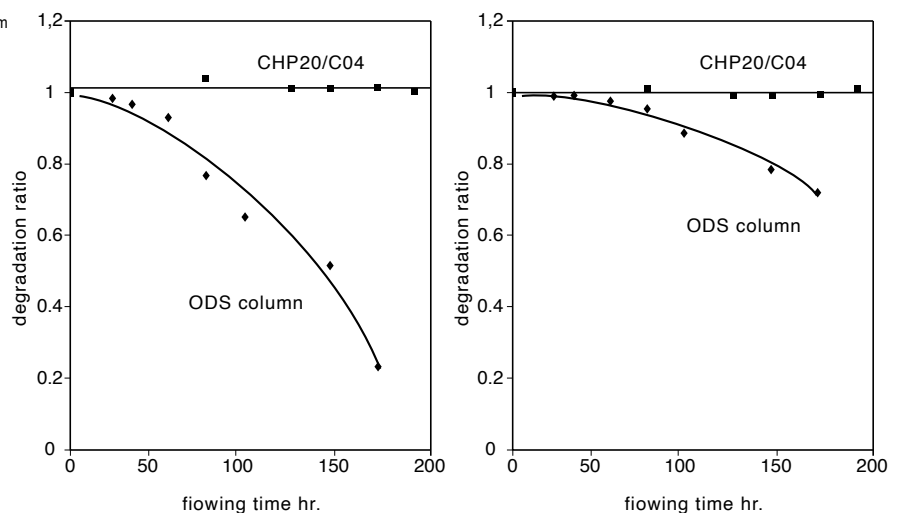

Application data of CHP series

Fig. 5-2 Separation of catecholamines

Conditions
 Column : MCI GEL™ CHP20/C04
 4.6mm I.D.×150mm
 Eluent : 50mM Na-phosphate pH2.0,
 1.5% Hexanesulfonic acid /
 CH₃CN=80/20
 Flow rate : 0.25mL/min
 Column temp. : ambient
 Detection : 280nm
 Sample : 1. Epinephrine
 2. Dopamine
 3. 5-Hydroxy tryptophan
 4. Serotonin
 5. Tryptophan

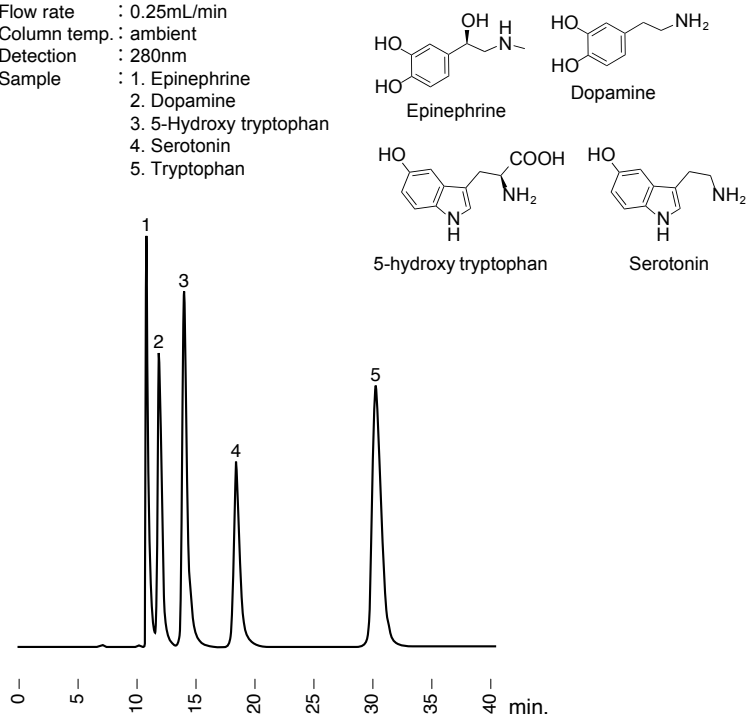

Fig. 5-3 Separation of phthalic acid esters

Conditions
 Column : MCI GEL™ CHP20/C04
 4.6mm I.D.×150mm
 Eluent : H₂O/CH₃CN=50/50
 Flow rate : 0.75mL/min
 Column temp. : 60°C
 Detection : 254nm
 Sample : 1. Dimethyl phthalate
 2. Diethyl phthalate
 3. Dipropyl phthalate

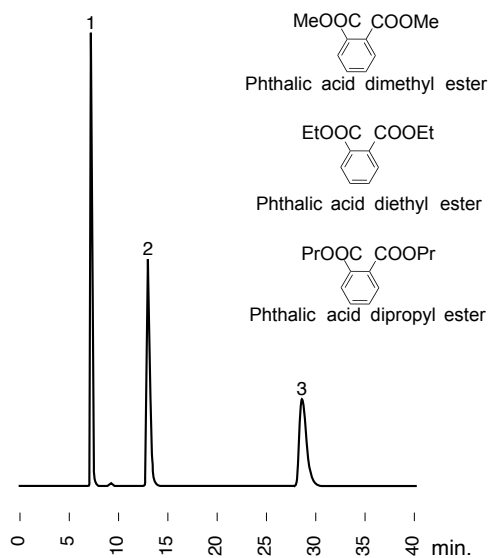

Fig. 5-4 Purine alkaloids

Conditions
 Column : MCI GEL™ CHP20/C04
 4.6mm I.D.×150mm
 Eluent : H₂O/CH₃CN=10/90
 Flow rate : 0.4mL/min
 Column temp. : 25°C
 Detection : 275nm
 Sample : 1.Theophylline
 2.Theobromine
 3.Caffeine

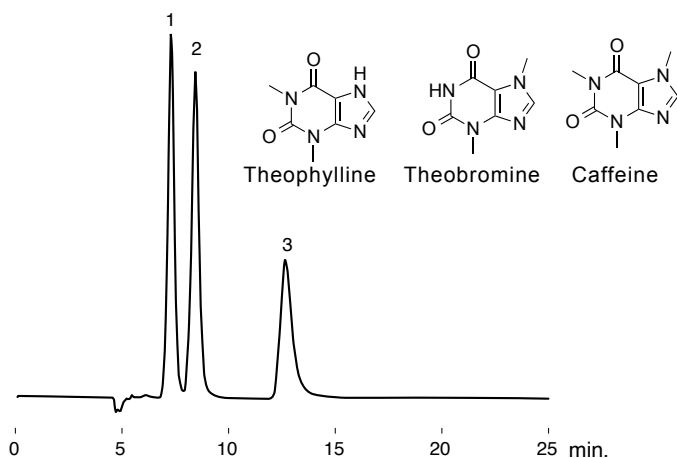
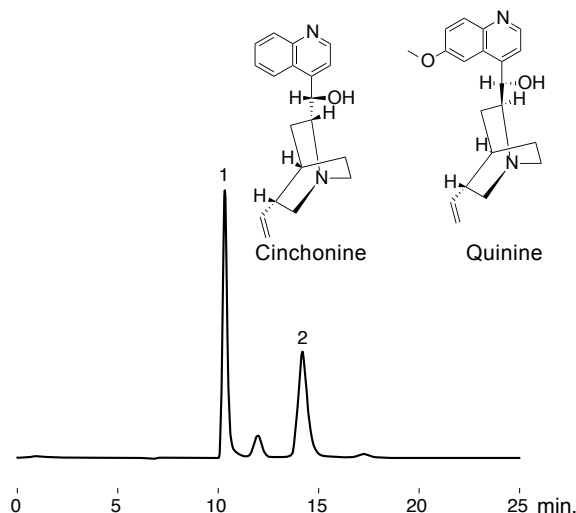

Fig. 5-5 Cinchona alkaloids

Conditions
 Column : MCI GEL™ CHP20/C04
 4.6mm I.D.×150mm
 Eluent : 0.1M NaH₂PO₄ pH2.0
 CH₃CN=88/12
 Flow rate : 0.3mL/min
 Column temp. : 25°C
 Detection : 275nm
 Sample : 1.Cinchonine
 2.Quinine



Application data of CHP series

Fig. 5-6 Uric acid and related compounds

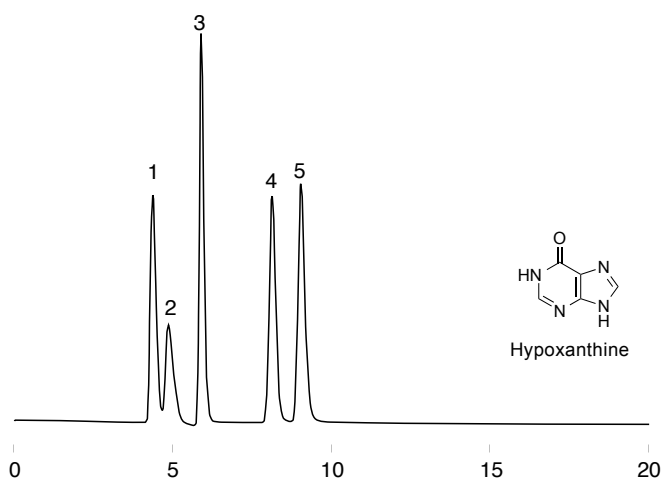

Conditions
 Column : MCI GEL™ CHP20/C04
 4.6mm I.D.×150mm
 Eluent : 10mM TBA/CH₃CN=75/25
 Flow rate : 0.4mL/min
 Column temp. : 25°C
 Detection : 284nm
 Sample : 1.Hypoxanthine
 2.Xanthine
 3.Theophylline
 4.Uric acid
 5.Orotic acid

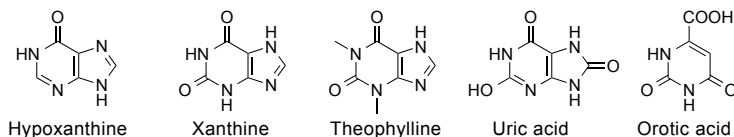

Comparison with an ODS column

Fig. 5-7 Bile acids

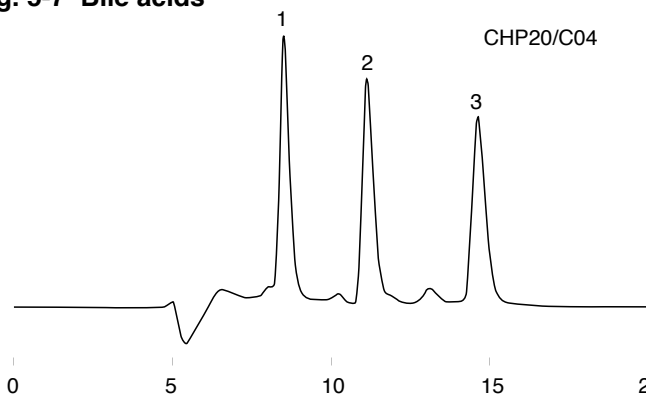

Conditions
 Column : MCI GEL™ CHP20/C04
 4.6mm I.D.×150mm
 Eluent : 50mM NaH₂PO₄ pH2.0
 /CH₃CN=40/60
 Flow rate : 0.3mL/min
 Column temp. : 25°C
 Detection : 210nm
 Sample : 1.Cholic acid
 2.Ursodeoxycholic acid
 3.Deoxycholic acid

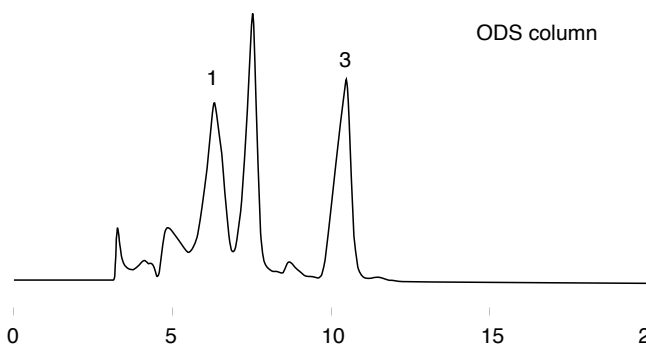
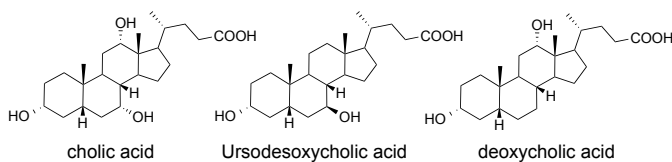

Conditions
 Column : ODS column (5μm)
 4.6mm I.D.×150mm
 Eluent : 50mM NaH₂PO₄ pH6.0
 /CH₃CN=40/60
 Flow rate : 0.3mL/min
 Column temp. : 25°C
 Detection : 210nm
 Sample : 1.Cholic acid
 2.Ursodeoxycholic acid
 3.Deoxycholic acid

Application data of CHP series

Fig. 5-8 Glycyrrhizae radix

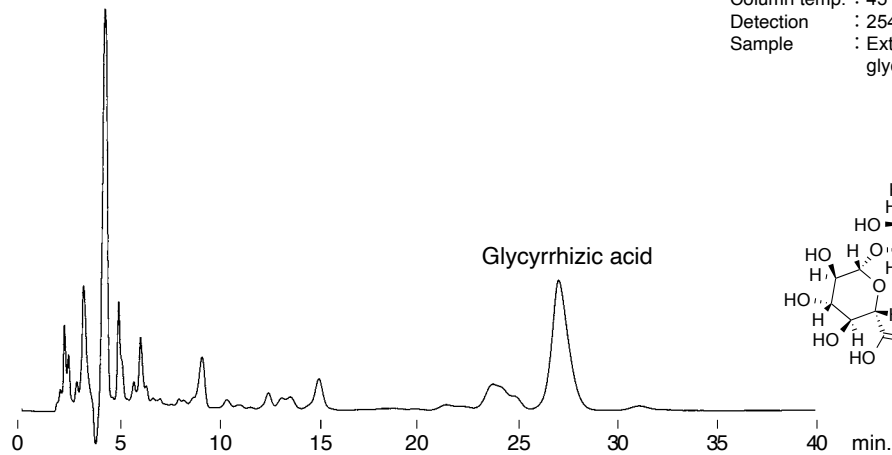

Conditions
 Column : MCI GEL™ CHP20/C04
 4.6mm I.D.×150mm
 Eluent : 2.06% acetic acid/CH₃CN
 =63/37
 Flow rate : 0.5mL/min
 Column temp. : 45°C
 Detection : 254nm
 Sample : Extract of
 glycyrrhizae radix

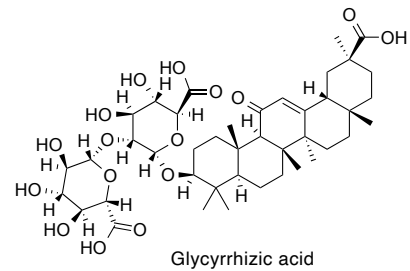
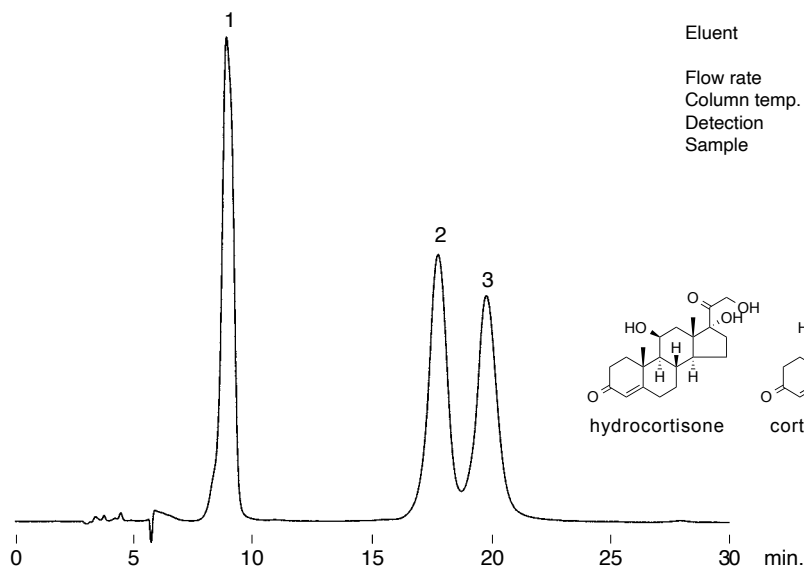
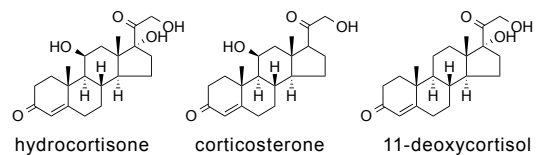

Fig. 5-9 Adrenal cortex hormones



Conditions
 Column : MCI GEL™ CHP20/C04
 4.6mm I.D.×150mm
 Eluent : H₂O/CH₃CN
 : 60/40
 Flow rate : 0.5mL/min
 Column temp. : 45°C
 Detection : 280nm
 Sample : 1.Hydrocortisone
 2.Corticosterone
 3.11-Deoxycortisol



Application data of CHP series

Fig. 5-10 Ingredients of medicine

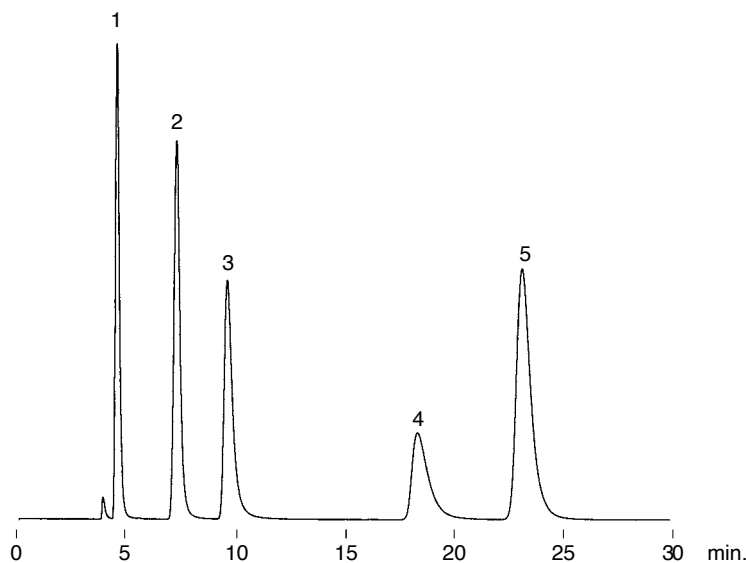

Conditions

Column : MCI GEL™ CMG20/C04
4.6mm I.D.×150mm
Eluent : 50mM phosphoric acid(pH2.0)/CH₃OH
=60/40
Flow rate : 0.5mL/min
Column temp. : 45°C
Detection : 254nm
Sample : 1.4-Dimethylaminoantipyrine
2.Antipyrine
3.Caffeine
4.Aspirin
5.Phenacetin

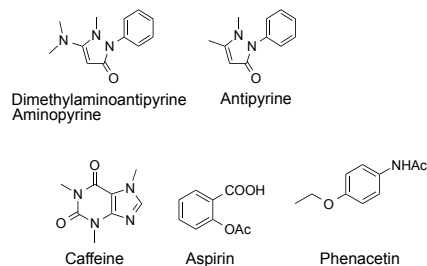

Comparison with an ODS column

Fig. 5-11 Sulfa drugs

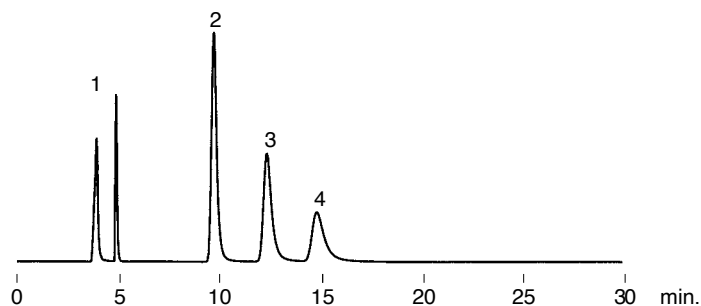

Conditions

Column : MCI GEL™ CMG20/C04
4.6mm I.D.×150mm
Eluent : 20mM phosphate pH6.8/CH₃CN
=82/18
Flow rate : 0.5mL/min
Column temp. : 45°C
Detection : 254nm
Sample : 1.Succinylsulfathiazole
2.Sulfanilamide
3.Sulfathiazole
4.Sulfamerazine

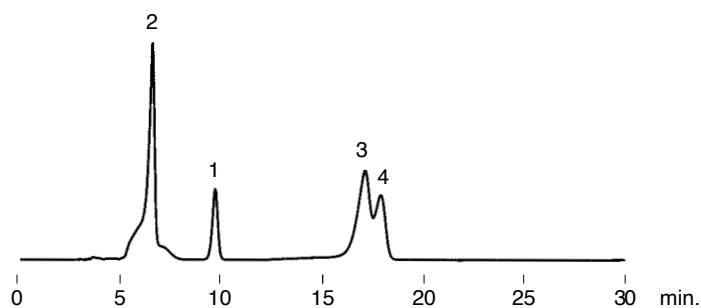
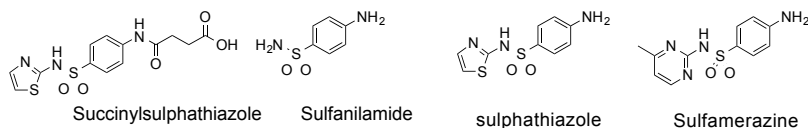

Conditions

Column : ODS column
4.6mm I.D.×150mm
Eluent : 20mM phosphate pH6.8/CH₃CN
=90/10
Flow rate : 0.5mL/min
Column temp. : 45°C
Detection : 254nm
Sample : 1.Succinylsulfathiazole
2.Sulfanilamide
3.Sulfathiazole
4.Sulfamerazine

Application data of CHP series

Fig. 5-12 Peptides

Conditions
 Column : MCI GEL™ CMG20/C04
 4.6mm I.D.×150mm
 Eluent : 0.1%TFA/CH₃CN
 =70/30
 Flow rate : 0.5mL/min
 Column temp. : 25°C
 Detection : 220nm
 Sample : 1.Gly-Tyr
 2.Met Enkephalin
 3.Leu Enkephalin
 4.Angiotensin II

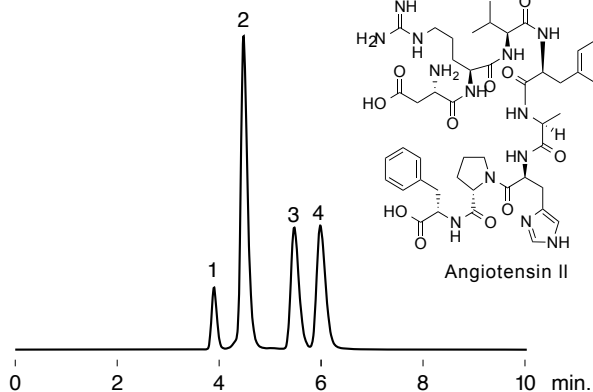
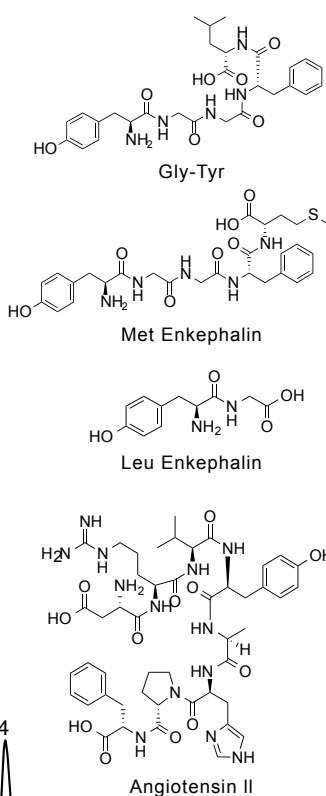

Fig. 5-13 Proteins

Conditions
 Column : MCI GEL™ CMG20/C04
 4.6mm I.D.×150mm
 Eluent : A:0.05%TFA/CH₃CN
 =80/20
 B:0.05%TFA/CH₃CN
 =20/80
 A→B 30min.linear
 Flow rate : 0.5mL/min
 Column temp. : 25°C
 Detection : 280nm
 Sample : 1.Ribonuclease A
 2.Cytochrome c
 3.α-Chymotrypsinogen A

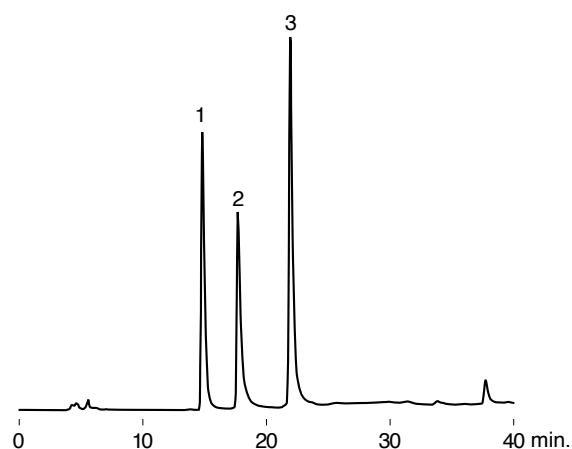

Fig. 5-14 Procainamide, Procaine

Conditions
 Column : MCI GEL™ CMG20/C04
 4.6mm I.D.×150mm
 Eluent : 20mM phosphate pH7.2/CH₃CN
 =65/35
 Flow rate : 0.5mL/min
 Column temp. : 45°C
 Detection : 254nm
 Sample : 1.Procainamide
 2.Procaine

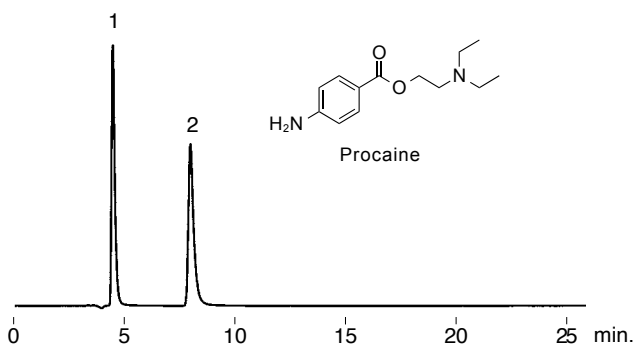
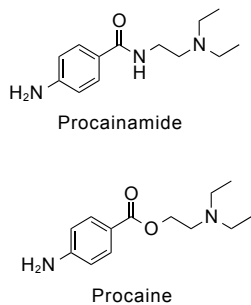
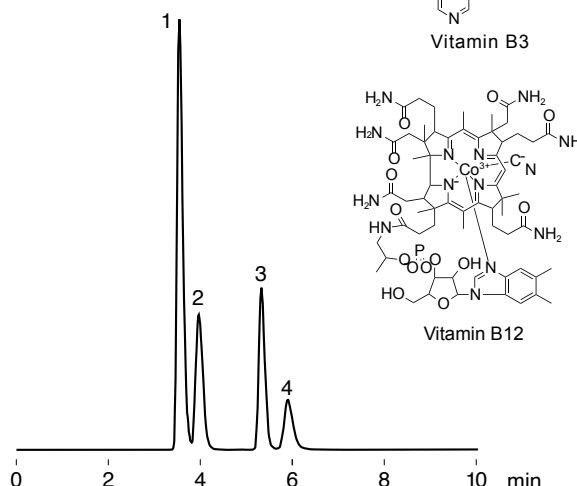
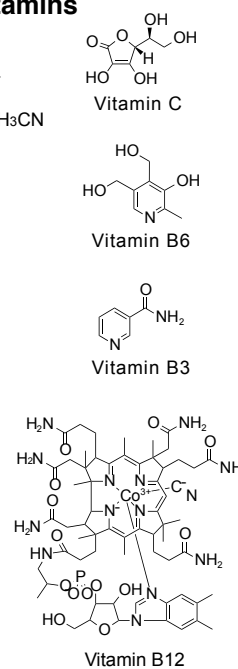

Fig. 5-15 Water-soluble vitamins

Conditions
 Column : MCI GEL™ CMG20/C04
 4.6mm I.D.×150mm
 Eluent : 8mM Na₂HPO₄ pH7.0/CH₃CN
 =85/15
 Flow rate : 0.5mL/min
 Column temp. : 25°C
 Detection : 254nm
 Sample : 1.Vitamin C
 2.Vitamin B6
 3.Vitamin B3
 4.Vitamin B12



Application data of CHP series

Fig. 5-16 Pravastatin sodium

Conditions
 Column : MCI GEL™ CHP20/C10 (10µm 250 ×4.6mm I.D.) and ODS (10µm 250 ×4.6mm I.D.)
 Eluent : A :0.1% Formic acid; B :0.1% Formic acid in AcCN;
 Gradient : 45%B-95%B over 29min.
 Flow rate : 1.00mL/min
 Column temp.: 25°C
 Detection : UV238nm
 Sample : Pravastatin sodium, Mevastatin and Simvastatin, 1mg/ml each;.
 Injection : 5µL

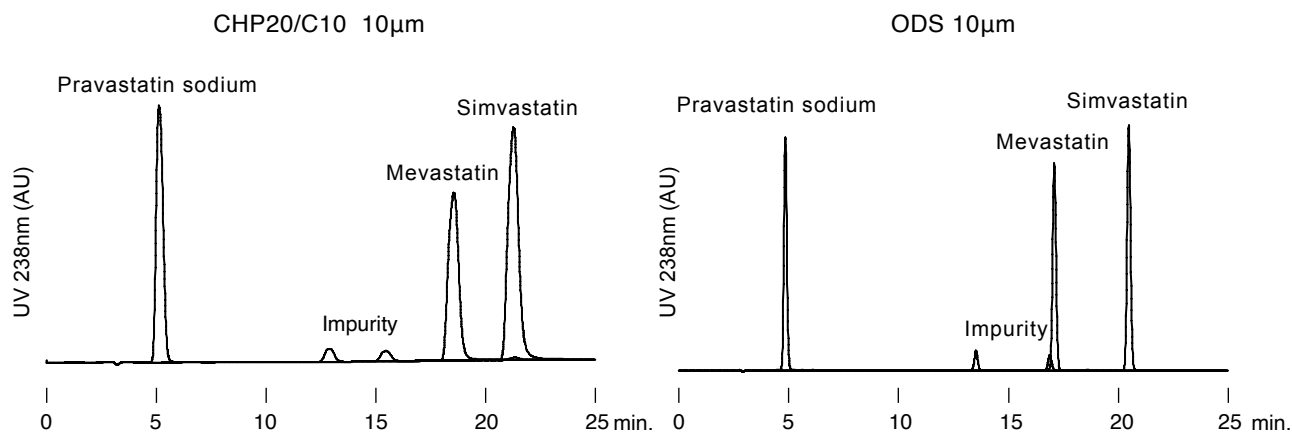
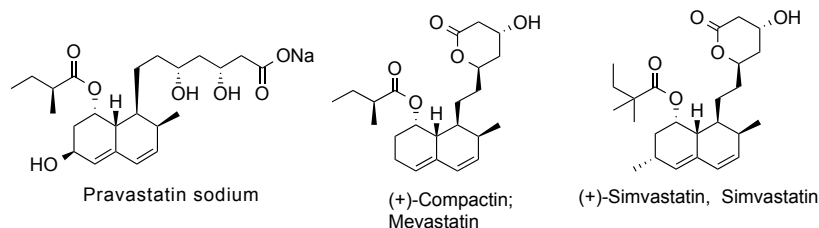
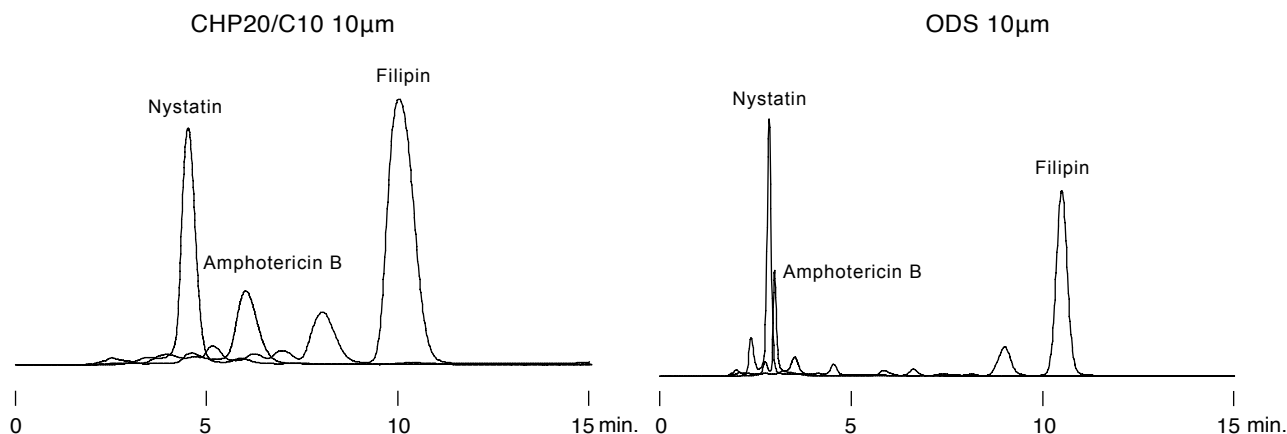
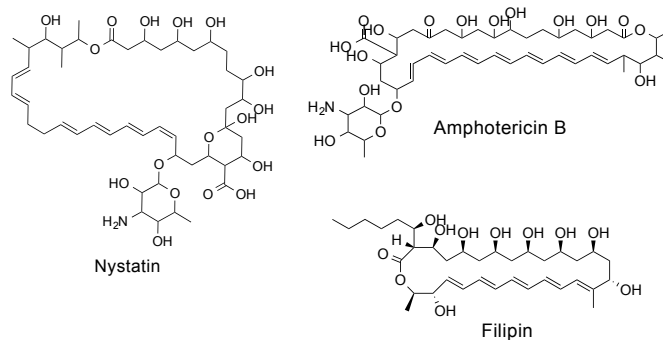

Fig. 5-17 Polyene antibiotics

Conditions
 Column : MCI GEL™ CHP20/C10 (10µm 250 ×4.6mm I.D.) and ODS (10µm 250 ×4.6mm I.D.)
 Eluent : A :0.1% Formic acid; B :0.1% Formic acid in AcCN; A/B=60/40;
 Flow rate : 1.00mL/min
 Column temp.: 25°C
 Detection : UV305nm for Nystatin, VIS405nm for Amphotericin B and UV340nm for Filipin;
 Sample : Pravastatin sodium, Mevastatin and Simvastatin, 1mg/ml each;.
 Injection : 10µL



Application data of CHP series

Fig. 5-18 Proteins

Conditions
 Column : MCI GEL™ CMG20/C10
 4.6mm I.D.×250mm
 Eluent : A 0.05% TFA/CH₃CN=80/20
 B 0.05% TFA/CH₃CN=30/70
 A → B 45min linear gradient
 Flow rate : 0.5mL/min
 Column temp. : 25°C
 Detection : 280nm
 Sample : 1. Ribonuclease A
 2. Cytochrome C
 3. Transferrin
 4. α-Chymotrypsinogen A
 5. β-Lactoglobulin

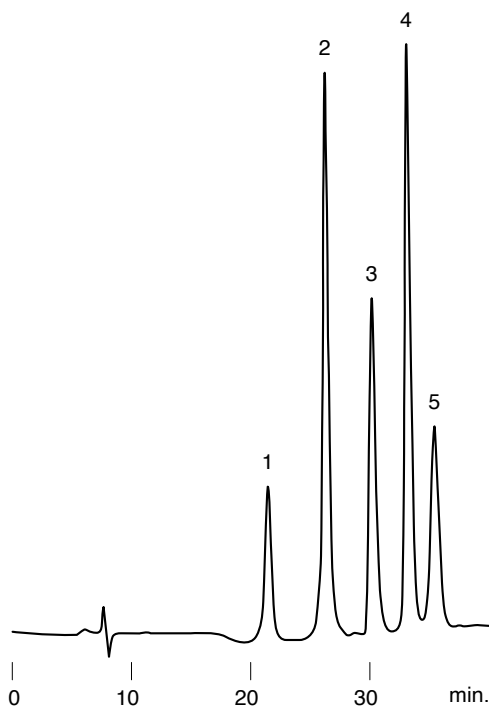
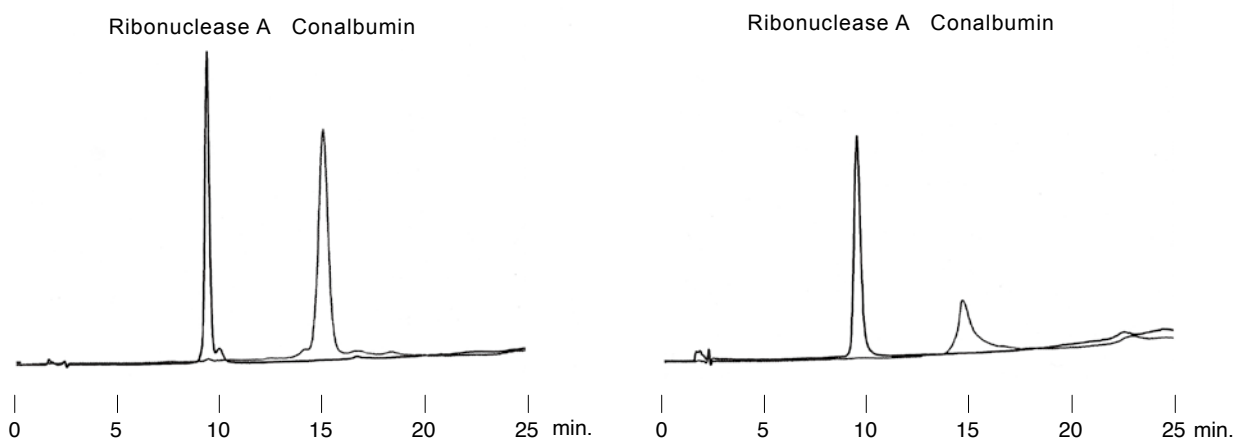

Fig. 5-19 Proteins

CHP20/C10 10μm

ODS 10μm



Conditions
 Column : 150 ×4.6mm I.D.
 Eluent : A :0.1% TFA;
 B :0.1% TFA in AcCN
 Flow rate : 1.00mL/min
 Column temp. : 20%B-60%B over 20min;
 Detection : UV280nm;
 Sample : Ribonuclease A and Conalbumin 2mg/ml;
 Injection : 10μL

Application data of CHP series

Fig. 5-20 Insulin

Conditions
 Column : MCI GEL™ CHP20/C10
 MCI GEL™ CMG20/C10
 ODS 10μm
 4.6mm I.D.×150mm
 Eluent : A) 0.1%TFA, H₂O
 B) 0.1%TFA, CH₃OH
 Gradient : 20%B→60%B over 20min.
 Flow rate : 1.0mL/min
 Column temp. : 40°C
 Detection : 280nm
 Sample : Insulin Glargine and human recombinant , 1mg/mL each
 Injection : 10μL

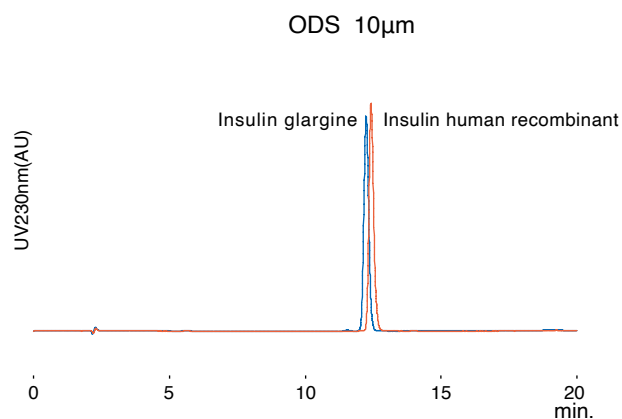
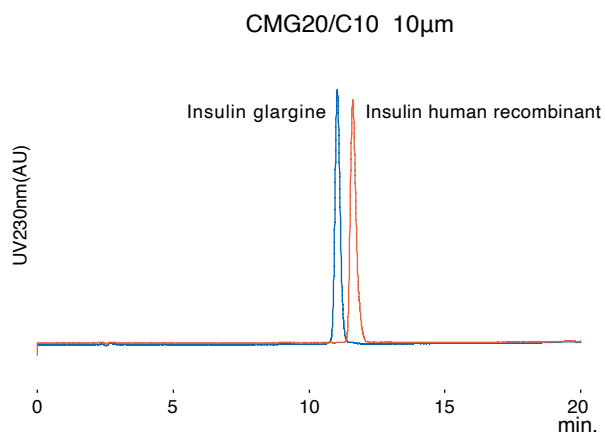
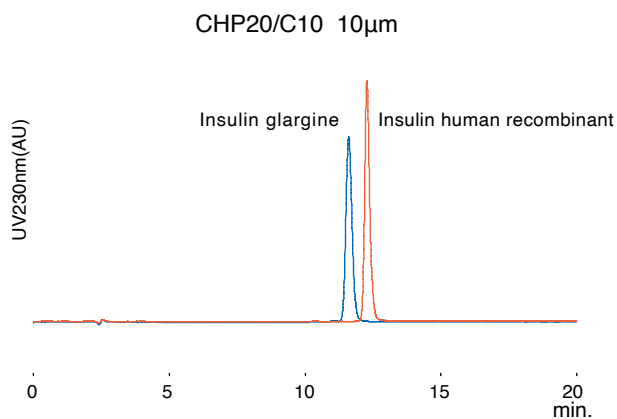
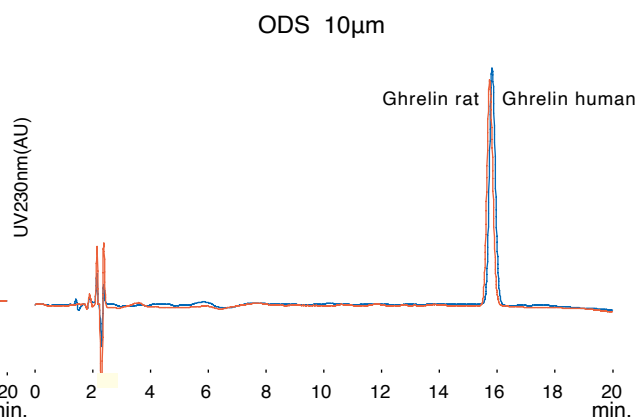
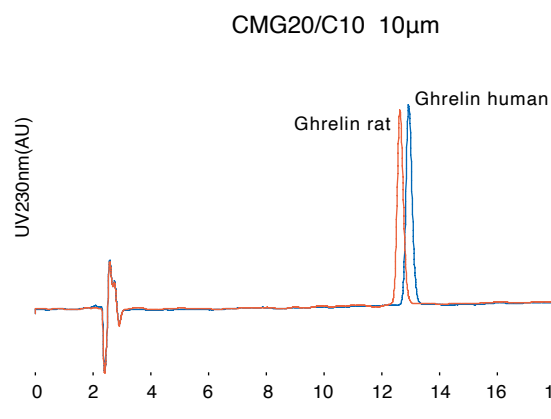

Fig. 5-21 Ghrelin

Conditions
 Column : MCI GEL™ CMG20/C10
 ODS 10μm
 4.6mm I.D.×150mm
 Eluent : A) 0.1%TFA, H₂O
 B) 0.1%TFA, AcCN
 Gradient : 10%B→60%B over 25min.
 Flow rate : 1.0mL/min
 Column temp. : 40°C
 Detection : 230nm
 Sample : Ghrelin rat and Ghrelin human ,0.1mmol/l each
 Injection : 10μL



Column selection guide
 1
 Ion exchange columns and materials
 2
 Ion chromatography columns and materials
 3
 Bioseparation columns and materials
 4
 Analytical and preparative chromatography for pharmaceutical applications
 5
 Critical separation columns
 6
 SPE sorbent series
 7
 MCI GEL™ column list
 8
 MCI GEL™ material list
 9
 Compounds index
 10

Application data of CHP series

Fig. 5-22 Leuprorelin

Conditions

Column : MCI GEL™ CHP20/C10
 MCI GEL™ CMG20/C10
 ODS 10 μ m
 4.6mm I.D.×150mm
 Eluent : A) 0.1%TFA, H₂O
 B) 0.1%TFA, AcCN
 Gradient : 20%B→60%B over 20min.
 Flow rate : 1.0mL/min
 Column temp.: 40°C
 Detection : 280nm
 Sample : Leuprorelin, LHRH human, LHRH salmon and Buserelin ,1mg/mL each
 Injection : 10 μ L

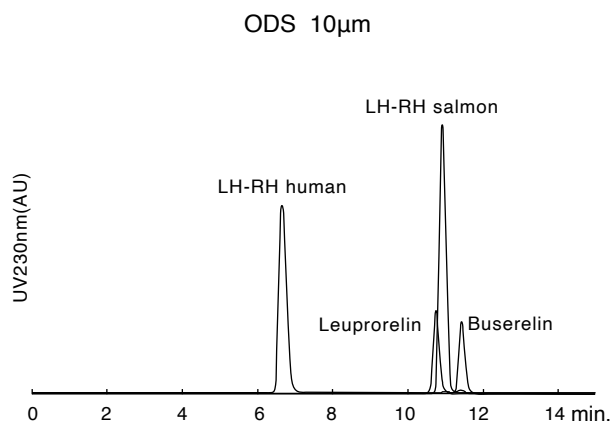
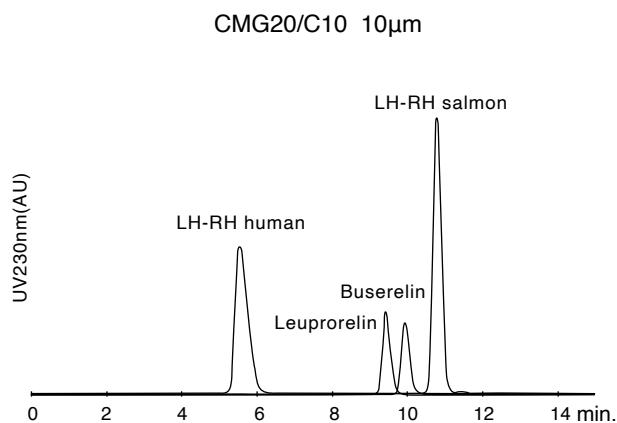
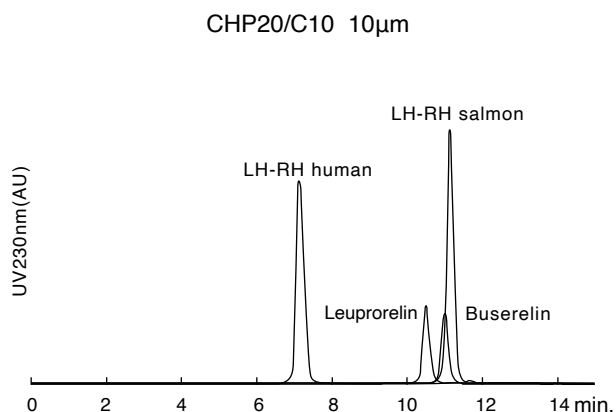
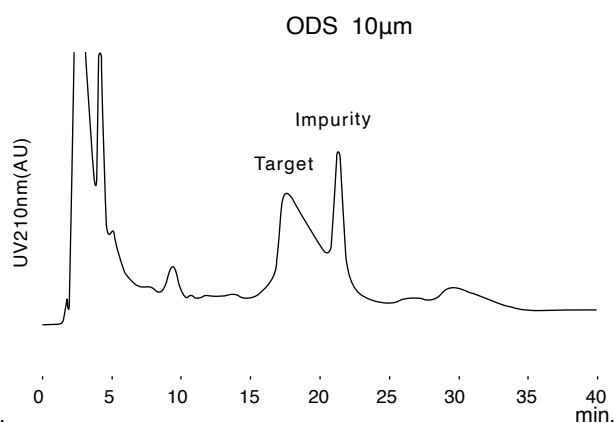
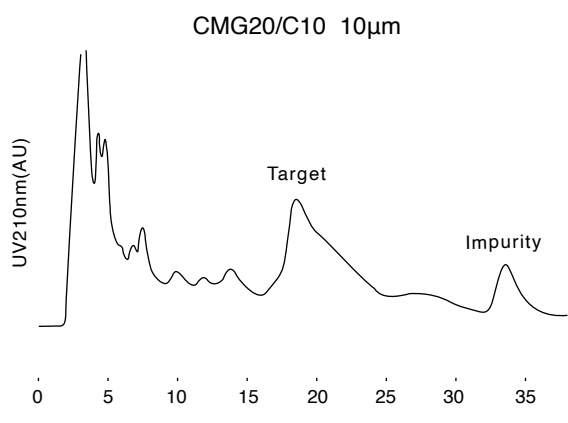

Fig. 5-23 Sifuvirtide

Conditions

Column : MCI GEL™ CMG20/C10
 ODS 10 μ m
 4.6mm I.D.×150mm
 Eluent : 0.1%TFA,/CH₃CN=68/32
 Flow rate : 1.0mL/min
 Column temp.: 40°C
 Detection : 210nm
 Sample : Sifuvirtide crude(purity 35.5%) 2.1mg/mL
 Injection : 0.4mL



- 1 Column selection guide
- 2 Ion exchange columns and materials
- 3 Ion chromatography columns and materials
- 4 Bioprocession columns and materials
- 5 Analytical and preparative for pharmaceutical applications
- 6 Chiral separation columns
- 7 SPE sorbent series
- 8 MCI GEL™ column list
- 9 MCI GEL™ material list
- 10 Compounds index

Application data of CHP series

Fig. 5-24 ssRNA Ladder Marker

Conditions
 Column : MCI GEL™ CMG20/C10
 ODS 10 μ m
 4.6mm I.D.×150mm
 Eluent : A)100mM TEAA, H₂O
 B)100mM TEAA, CH₃CN
 Gradient : CHP10/C10 10%B→40%B over 30min
 ODS 10 μ m 8%B→40%B over 30min
 Flow rate : 1.0mL/min
 Column temp.: 40°C
 Detection : 260nm
 Sample : 14-30 ssRNA Ladder Marker [max.0.04mg/mL]
 Injection : 5 μ L

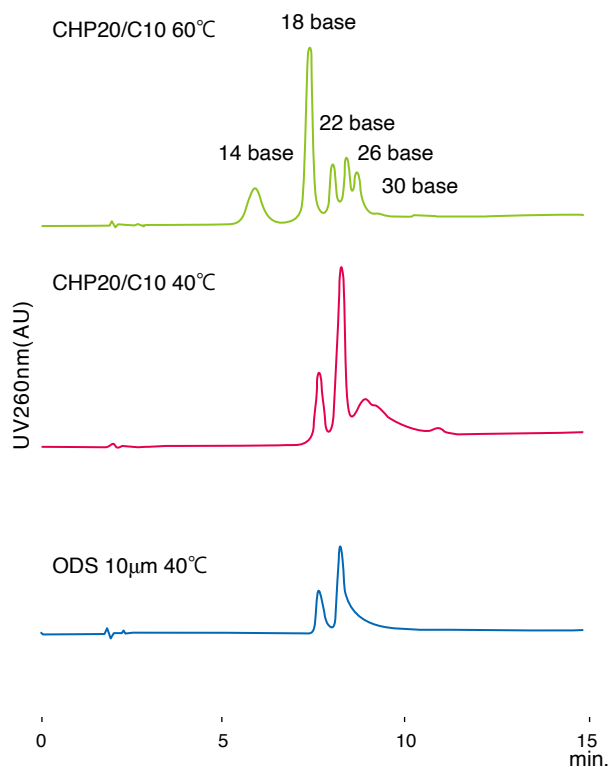
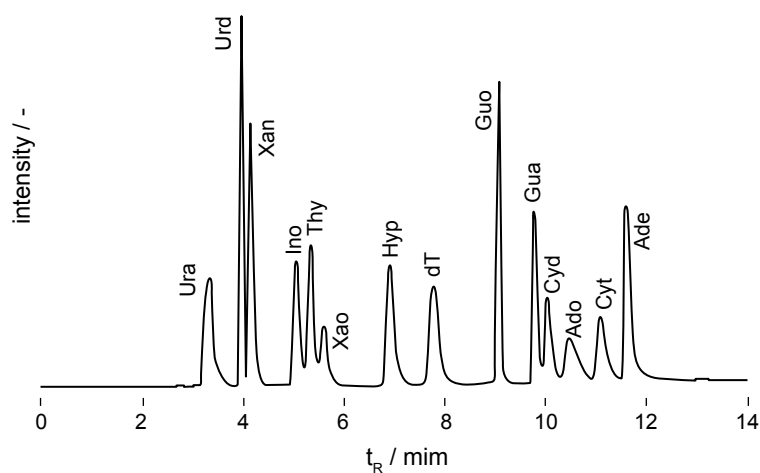

Fig. 5-25 Nucleotide

Conditions
 Column : MCI GEL™ CHK40/C04
 4.6mm I.D.×150mm
 Eluent : A)19 mM H₃PO₄ / 1 mM NaH₂PO₄ / 5.0% ACN
 B)20 mM Na₂HPO₄ / 100 mM NaClO₄ / 30% ACN
 Gradient : 0-4.0min 0%B 4.0-5.0min 0→30%B 5.0min-6.0min 30%B 6.0min-7.0min 30→50%B
 7.0min-10.0min 50→65%B 10.0min-11.0min 65%B 11.0min- 0%B
 Flow rate : 0.8mL/min
 Column temp.: 50°C
 Detection : UV260nm
 Sample : 1.Ura, 2.Xan, 3.Thy, 4.Hyp, 5.Gua, 6.Cyt, 7.Ade, 8.Urd, 9.Xao, 10.dT, 11.Ino, 12.Guo, 13.Cyd, 14.Ado
 Injection : 20 μ L



(Data provided by Professor Yokoyama of Yokohama National University)

Application data of CHP series

Fig. 5-26 Linalool

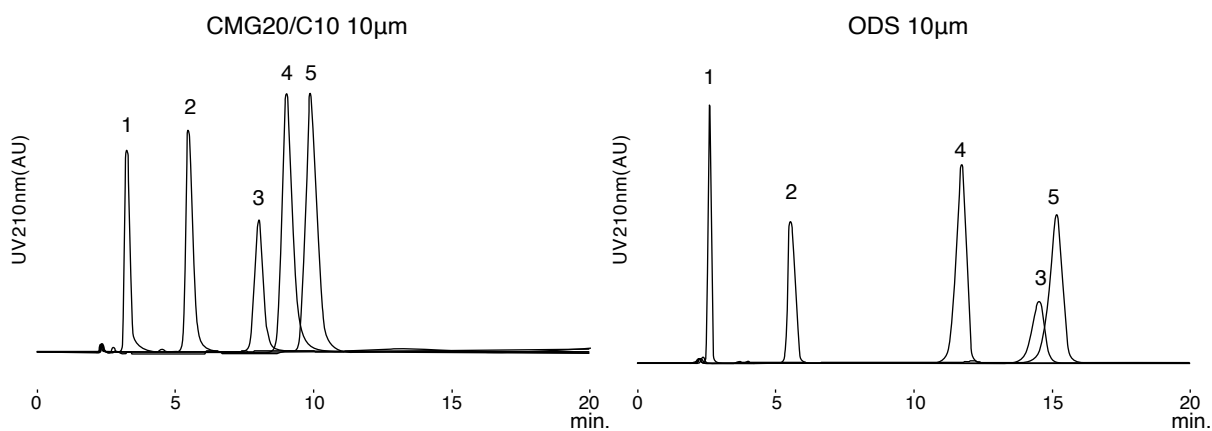

Conditions
 Column : MCI GEL™ CMG20/C10
 ODS 10µm
 4.6mm I.D.×150mm
 Eluent : Hexan/Ethanol=99.5/0.5
 Flow rate : 1.0mL/min
 Column temp.: 40°C
 Detection : 210nm
 Sample : 1:Linalyl Acrylate 1mg/mL
 2:Linalool 1mg/mL
 3:β-Citronellol 1mg/mL
 4:Nerol 0.5mg/mL
 5:Geraniol 0.5mg/mL
 Injection : 10µL

Fig. 5-27 Coriander

Conditions
 Column : MCI GEL™ CMG20/C10
 4.6mm I.D.×150mm
 Eluent : Hexan/Ethanol=99.5/0.5
 Flow rate : 1.0mL/min
 Column temp.: 40°C
 Detection : 210nm
 Sample : Coriander
 Injection : 10µL

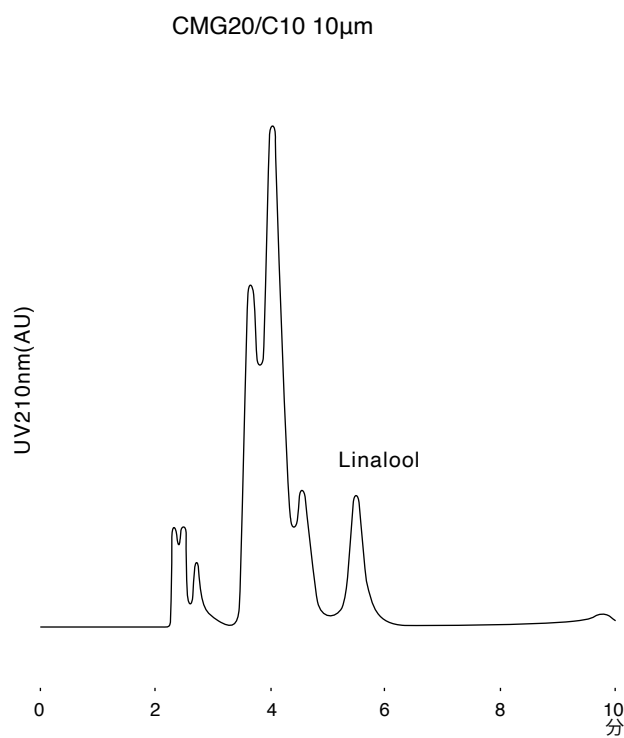

Application data of CHP series

Fig. 5-28 Application data of CHK40/C04 : Sepatation of Sartans

Conditions
 Column : MCI GEL™ CHK40/C04
 4.6mm I.D.×150mm
 Eluent : A) 10 mM NaH₂PO₄ +0.2 mM Na₂HPO₄ (25%ACN)
 B) 10 mM NaH₂PO₄ +1.0 mM Na₂HPO₄ (40%ACN)
 Gradient : 0.5min 0%B 0.5-2.0min 50%B
 2.0min-- 90%B
 Flow rate : 1.0mL/min
 Column temp. : 50°C
 Detection : UV
 Sample : Candesartan(CAN),Losartan(LOS),
 Valsartan(VAL), Irbesartan(IRB)
 Injection : 20μL

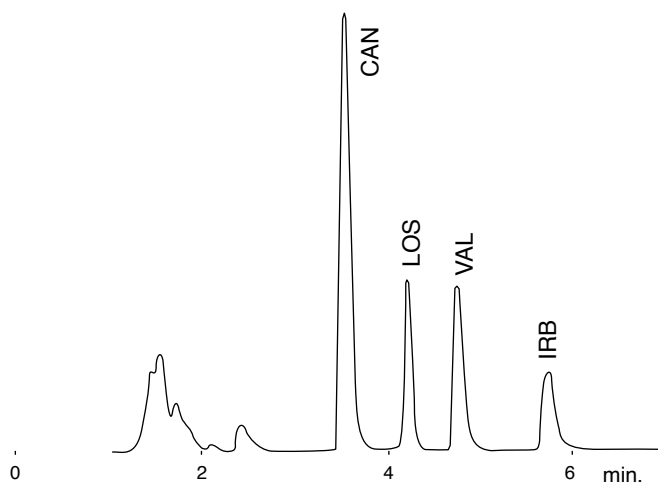
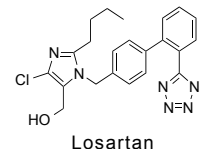
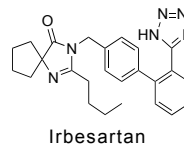
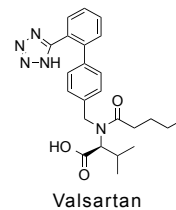
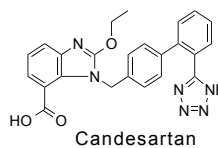

(Data provided by Professor Yokoyama of Yokohama National University)

(Polyphenon 60)

Fig. 5-29 Modified Styrene Divinylbenzene CHP07/C04

Conditions
 Column : MCI GEL™ CHP07/C04
 4.6mm I.D.×150mm
 Eluent : CH₃OH/10mM-Acetic acid=60/40
 Flow rate : 0.46mL/min
 Column temp. : 60°C
 Detection : 280nm
 Sample : Polyphenon 60(10mg/mL) each 10μL

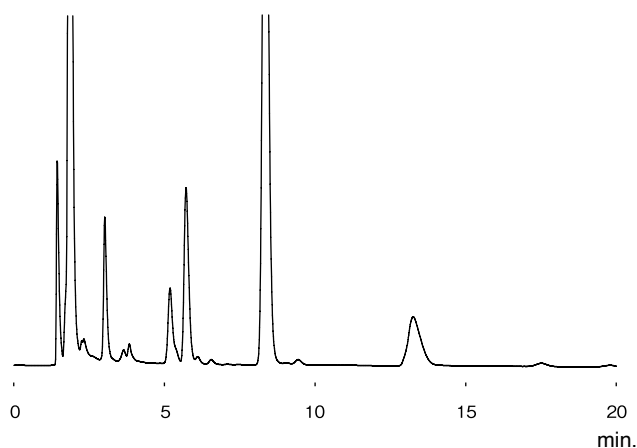
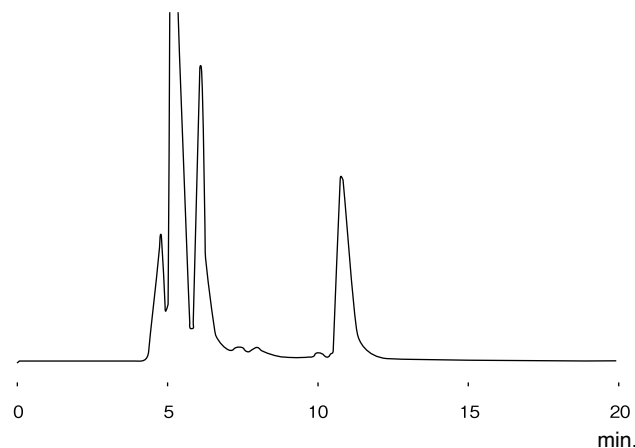

Fig. 5-30 Styrene Divinylbenzene CHP20/C04

Conditions
 Column : MCI GEL™ CHP20/C04
 4.6mm I.D.×150mm
 Eluent : CH₃OH/10mM-Acetic acid=60/40
 Flow rate : 0.46mL/min
 Column temp. : 60°C
 Detection : 280nm
 Sample : Polyphenon 60(10mg/mL) each 10μL



Application data of CHP series

(TritonX-100)

Fig. 5-31 C18-alkylated aliphatics CHPOD/C04

Conditions
 Column : MCI GEL™ CHPOD/C04
 4.6mm I.D.×150mm
 Eluent : 50vol%CH₃CN
 Flow rate : 0.50mL/min
 Column temp.: 40°C
 Detection : 254nm
 Sample : Triton X-100
 (Polyoxyethylene octyl phenyl ether)
 1% each 10μL

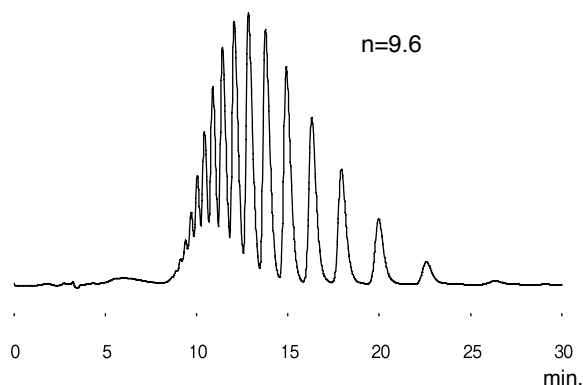
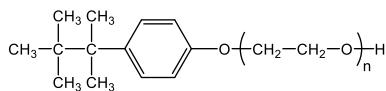

Fig. 5-32 ODS (5μm)

Conditions
 Column : ODS (5μm)
 4.6mm I.D.×250mm
 Eluent : 50vol%CH₃CN
 Flow rate : 1.00mL/min
 Column temp.: 40°C
 Detection : 254nm
 Sample : Triton X-100
 (Polyoxyethylene octyl phenyl ether)
 1% each 10μL

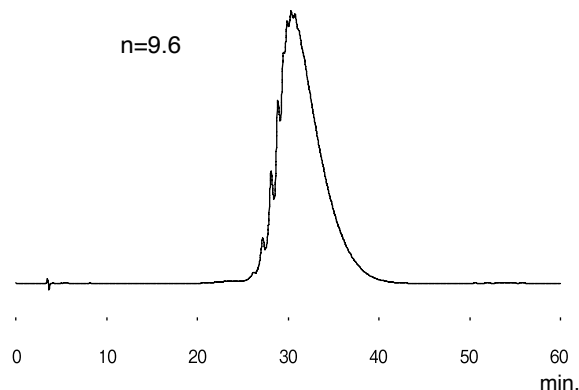
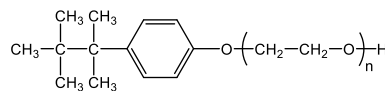
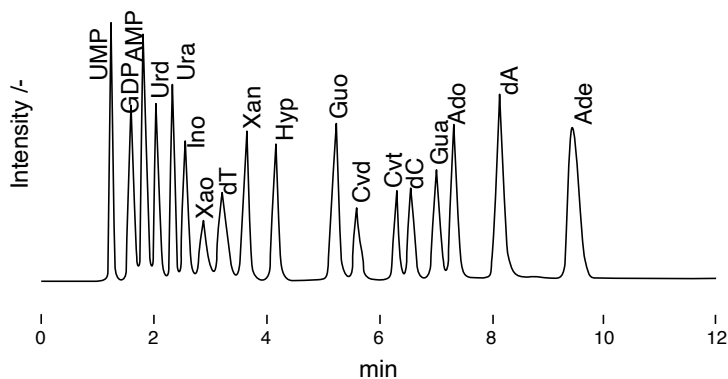
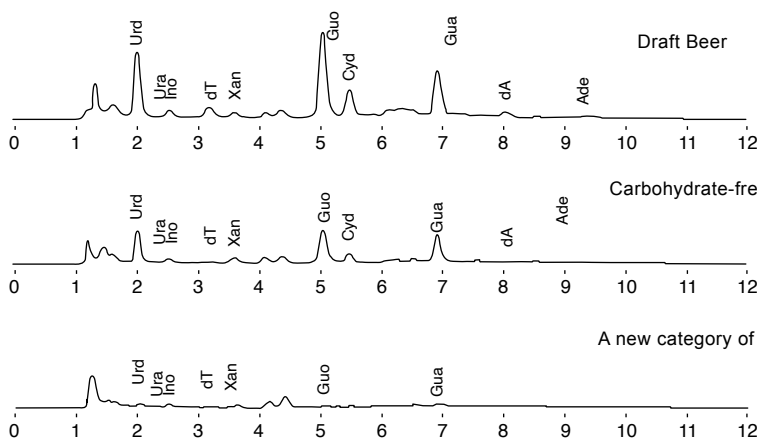

Fig. 5-33 Application data of Nucleic base/Nucleoside and Beer

Conditions
 Column : MCI GEL™ CHK45/C05
 4.6mm I.D.×150mm
 Eluent : A) 8 mM H₃PO₄
 B) 10 mM H₃PO₄ /30% ACN
 Gradient : 0-0.7min 0%B 0.7-3.0min 0→40%B 3.0-3.2min 40%B
 3.2-3.5min 40→80%B 3.5-8.0min 80%B 8.0min-- 0%B
 Flow rate : 1.3mL/min
 Column temp.: 45°C
 Detection : UV260nm
 Injection : 20μL



Analysis of various category beer



(Data provided by Professor Yokoyama of Yokohama National University)

CHP material series

Analytical and preparative chromatography columns and materials for pharmaceutical applications

MCI GEL™ CHP material series are chromatography materials of porous type polymers.

Because polymeric materials are chemically stable, wide pH range, from acidic to alkaline eluents are able to be applied to MCI GEL™ CHP material series.

MCI GEL™ CHP50 series and CHP20 series are both ST/DVB polymers, but they differences in porosity. Pore size of CHP20 series is fairly larger than that of CHP50 series. Appropriate packing material can be selected in accordance with molecular size of injection samples.

● CHP material series

Base polymer	Functional group	Product name	Particle size [μm]	Pore diameter [nm]	Main application	Equivalent HPLC column
Styrene Divinylbenzene	None	CHP20/P20	20	45	drug compounds Peptides Proteins	CHP20/C04 CHP20/C10
		CHP20/P30	30			
		CHP20/P50	50			
		CHP20/P70	70			
		CHP20/P120	120			
	None	CHP50/P20	20	25		—
		CHP50/P30	30	25		CHP20/C10
		CSP50/P10	10	25		CHP20/C10
	Br	CHP07/P120	120	25		CHP07/C04
CHP07/C10						
Polymethacrylate	None	CMG20/P10	10	25	CMG20/C04	
		CMG20/P30	30		CMG20/C10	

Application data of CHP 50

Fig. 5-34 Phthalic acid esters

Conditions
 Column : MCI GEL™ CHP50/P20, 10mm I.D.×250mmL
 Eluent : H₂O/CH₃CN=20/80
 Flow rate : 0.75mL/min
 Column temp. : 25°C
 Detection : 254nm,
 Sample : 1.Dimethyl phthalate 0.5%
 2.Dipropyl phthalate 0.5%
 3.Dibutyl phthalate 0.5%
 Injection : 100μL

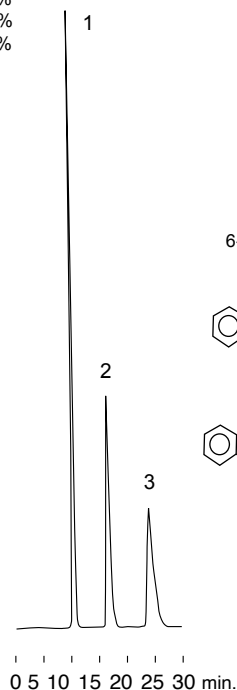
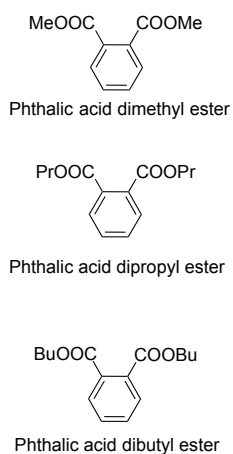

Fig. 5-35 Penicilin antibiotics

Conditions
 Column : MCI GEL™ CHP series, 10mm I.D.×250mmL
 Eluent : CH₃OH/0.05M Phosphate buffer (pH8.0)=60/40
 Flow rate : 2.18mL/min
 Column temp. : 25°C
 Detection : 254nm,
 Sample : 1.6-Aminopenicillanic acid
 2.Penicillin G
 3.Penicillin V
 Injection : 100μL

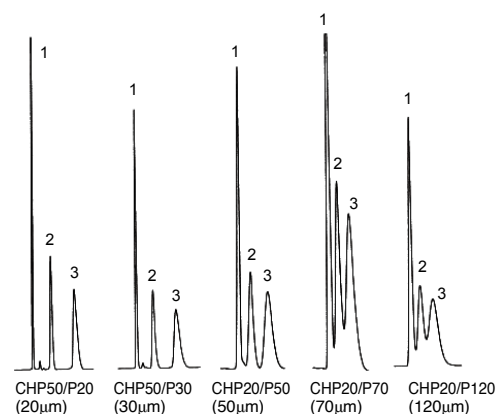
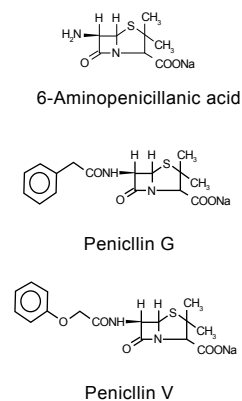
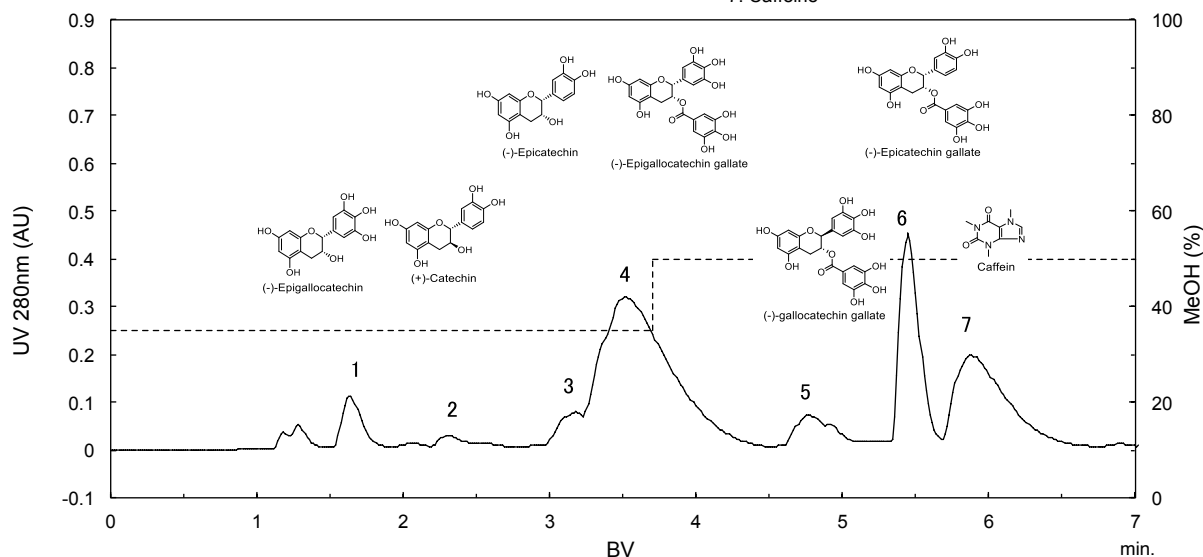

Fig. 5-36 Extract of green tea leaves

Conditions
 Column : MCI GEL™ CHP50/P20, 32mm I.D.×465mm
 Eluent : 0–185min, CH₃OH:0.01M Acetic acid(35:65)
 185–350min, CH₃OH:0.01M Acetic acid(50:50)
 Flow rate : 7.48mL/min
 Detection : 280nm
 Sample : extract of green tea leaves, injection volumn 18.7mL
 1. Epigallocatechin
 2. Catechin
 3. Epicatechin
 4. Epigallocatechin gallate
 5. Gallo catechin
 6. Epicatechin gallate
 7. Caffeine



Application data of CHP 20

Fig.5-37 Senna pulv. extract

Conditions

Chromatogram A	Chromatogram B	Chromatogram C
Column : MCI GEL™ CHP20/C10 4.6mm I.D.×250mm	Column : MCI GEL™ CHP20/P20 10.0mm I.D.×250mm	Column : MCI GEL™ CHP20/P30 10.0mm I.D.×250mm
Eluent : CH ₃ OH/1% Acetic acid = 60/40 (vol.)	Eluent : CH ₃ OH/1% Acetic acid = 60/40 (vol.)	Eluent : CH ₃ OH/1% Acetic acid = 60/40 (vol.)
Flow rate : 0.5mL/min	Flow rate : 2.4mL/min	Flow rate : 2.4mL/min
Detection : 270nm	Detection : 270nm	Detection : 270 nm
Sample : Extract of senna pulv. 10μL	Sample : Extract of senna pulv. 80μL	Sample : Extract of senna pulv. 80μL

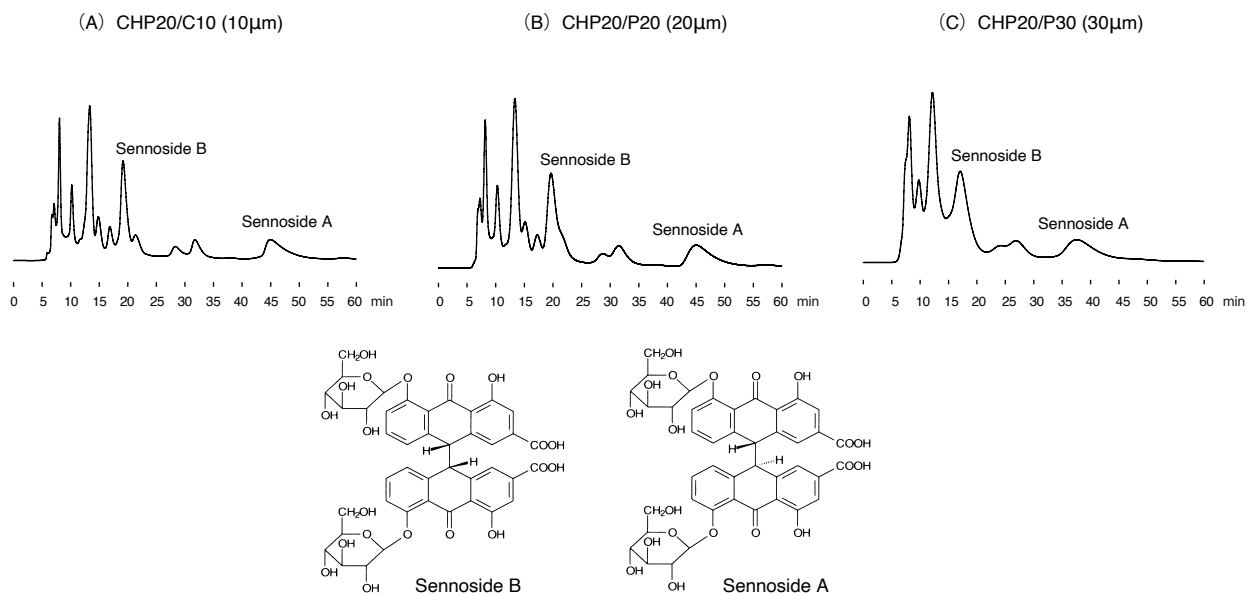
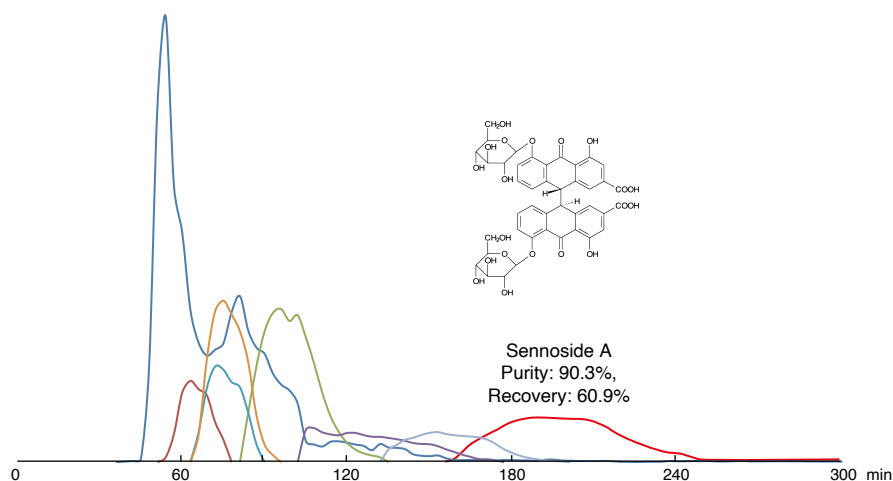

Fig. 5-38 Elution profile of senna pulv. extract separated on MCI GEL™ CHP20/P30

Conditions

Column : MCI GEL™ CHP20/P30 32mm I.D.×490mm
Eluent : CH ₃ OH + 1% Acetic acid = 60 + 40 (vol.)
Flow rate : 7.88mL/min
Detection : 270 nm
Sample : Extract of senna pulv., partially purified by Diaion HP20
Injected amount : 39.4mL



Application data of CHP series

Fig. 5-39 Elution profile of gardenia fructus extract separated on MCI GEL™ CHP20/P30

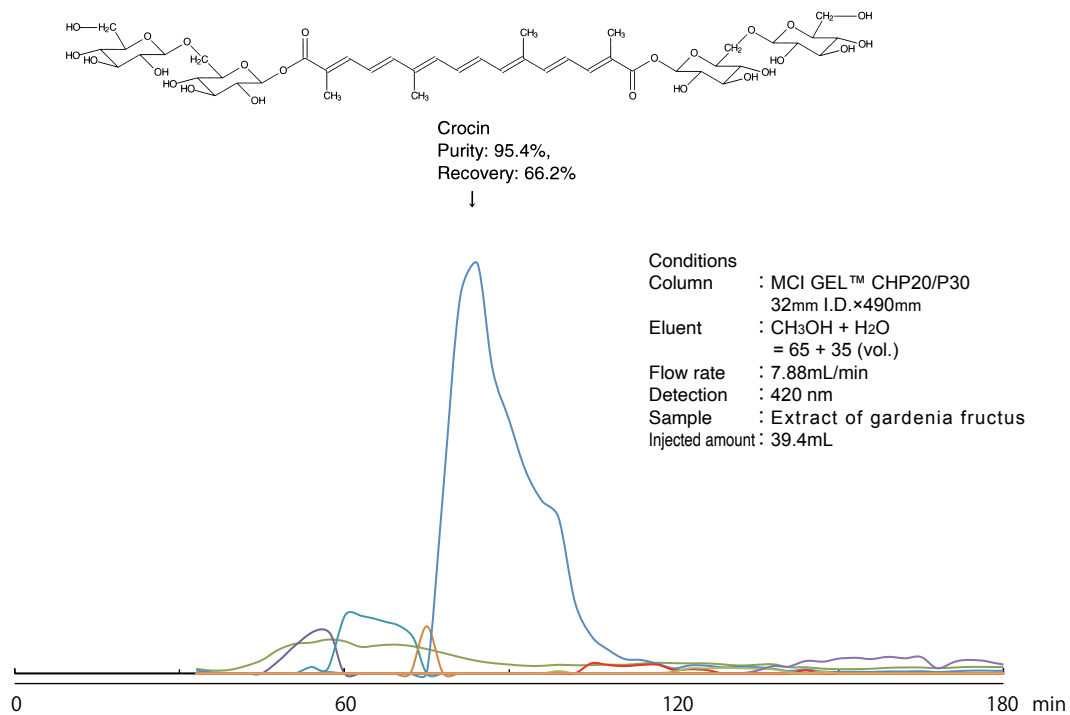
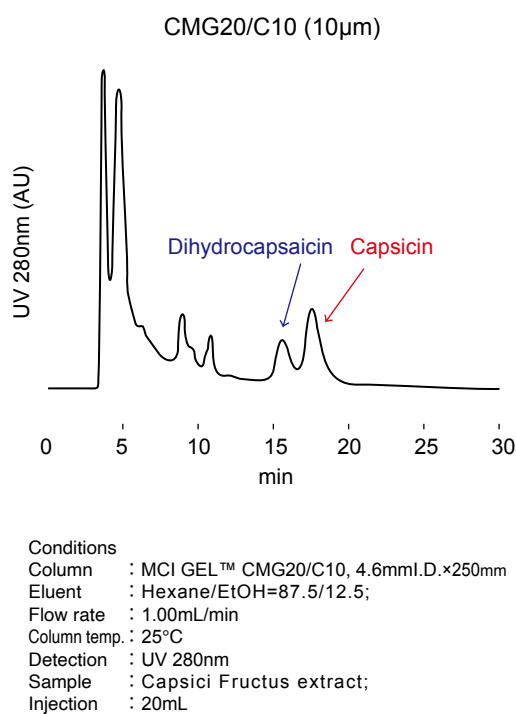
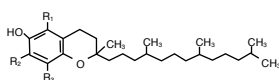

Fig. 5-40 Capsaicin



Application data of CHP series

Tocopherol



- | | R ₁ | R ₂ | R ₃ |
|-------------------------|-----------------|-----------------|-----------------|
| 1. α -tocopherol | CH ₃ | CH ₃ | CH ₃ |
| 2. β -tocopherol | CH ₃ | H | CH ₃ |
| 3. γ -tocopherol | H | CH ₃ | CH ₃ |
| 4. δ -tocopherol | H | H | CH ₃ |

Tocotrienol

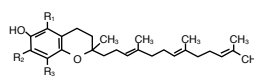

- | | R ₁ | R ₂ | R ₃ |
|--------------------------|-----------------|-----------------|-----------------|
| 5. α -tocotrienol | CH ₃ | CH ₃ | CH ₃ |
| 6. β -tocotrienol | CH ₃ | H | CH ₃ |
| 7. γ -tocotrienol | H | CH ₃ | CH ₃ |
| 8. δ -tocotrienol | H | H | CH ₃ |

Fig. 5-41 Vitamin E in Rice Bran Oil

Conditions
 Column : MCI GEL™ CMG20/C10
 4.6mm I.D.×150mm
 Eluent : Hexane-EtOH = 98/2 (vol.)
 Flow rate : 0.5mL/min
 Detection : 295nm
 Sample : Rice Bran Oil, 50mg/mL
 Injection : 10 μ L

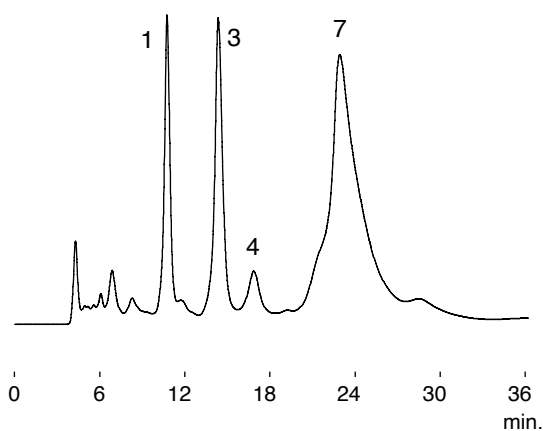

Fig. 5-42 Elution profile of Rice Bran Oil in preparative scale

Conditions
 Column : MCI GEL™ CMG20/P30
 20mm I.D.×500mm
 Eluent : Hexane/C₂H₅OH = 98/2 (vol.)
 Flow rate : 4.7mL/min
 Detection : 295 nm
 Sample : Rice Bran Oil, 50mg/mL
 Injection : 1260 μ L

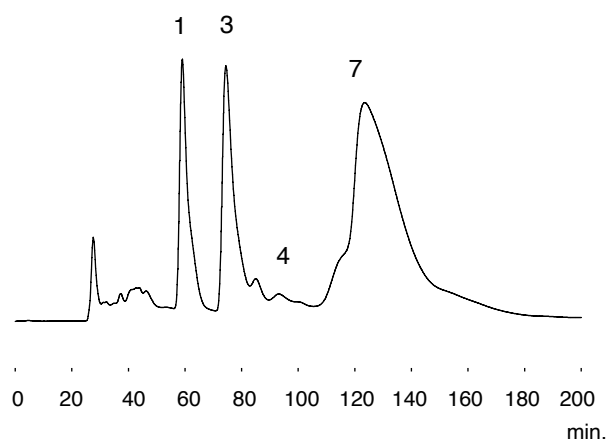
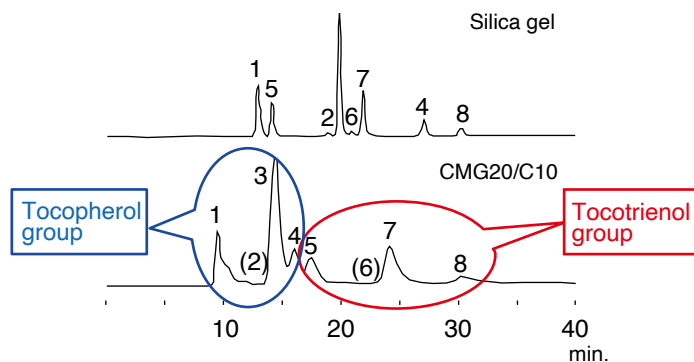

Fig. 5-43 Mixture of tocopherol and tocotrienol : Comparison with silica gel column

Conditions
 Column : 1. Silica gel 5SIL, 4.6mm I.D.×250mm
 2. MCI GEL™ CMG20/C04, 4.6mm I.D.×150mm
 Eluent : 1. Hexane/EtOH = 99/1
 2. Hexane/EtOH = 98/2
 Flow rate : 1.0mL/min
 Column temp. : 25°C
 Detection : UV 292nm
 Sample : Mixture of tocopherol and tocotrienol
 Injection : 10 μ L (1mg/mL)



○ Chiral separation columns MCI GEL™ CRS10W (DLAA) MCI GEL™ CRS15W (LDAA)



CRS10W 4.6×50



CRS15W 4.6×50

MCI GEL™ column	Column dimensions	Particle size (μm)	USP
MCI GEL™ CRS10W	4.6×50mm	3	L32
MCI GEL™ CRS15W	4.6×50mm	3	L32

Separation mechanism and performance of MCI GEL™ CRS series

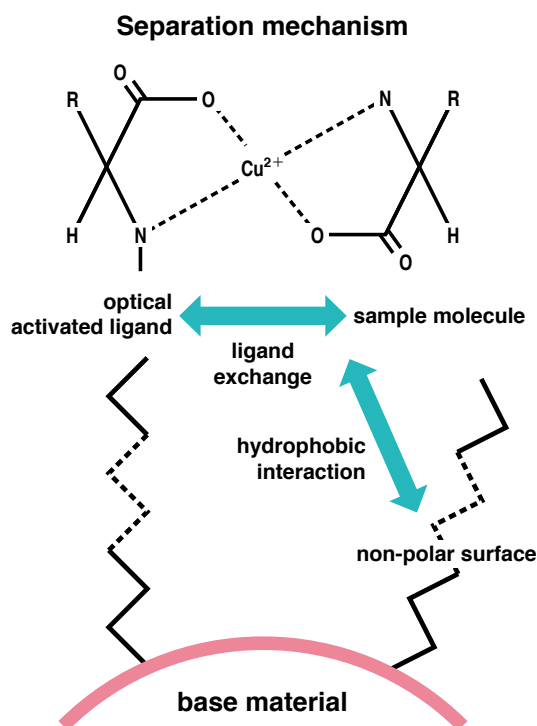

● Separation mechanism

MCI GEL™ CRS10W and its companion product MCI GEL™ CRS15W (an optical isomer of CRS10W) are based on a 3μm with 10nm mean pore diameter of silica gel coated with N,N-Dioctyl-L(or D)-alanine which is a novel optical activated ligand. The chiral resolution mechanism is a combination of ligand exchange and hydrophobic interaction. A copper sulfate aqueous solution is used as an eluent. Elution samples are directly detected at wave length of 254 nm because complex compound, composed of sample molecule and copper in the eluent, are object of detection. With the CRS10W, D-isomers generally elute in front of L-isomers while L-isomers elute ahead of D-isomers on the CRS15W. The hydrophobic interaction mechanism allows hydrophilic samples to elute faster than hydrophobic molecules. Long alkyl chain or aromatic compounds will elute late or require an organic solvent (CH₃CN or CH₃OH, max. of 15v/v%) to prevent adsorption onto the stationary phase.

Application of CRS10W Fig. 6-1 DL-Isoleucine

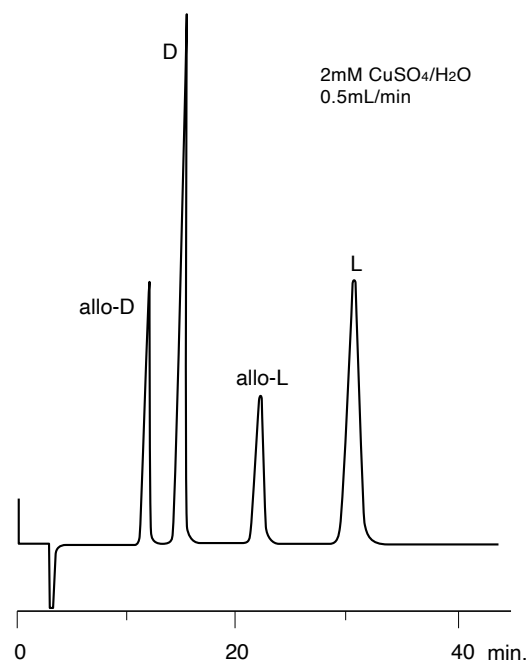

● Separation performance

1. The CRS series columns separate over 20 D,L-α-Amino acids by only single column. The columns separate not only α-Amino acids but also α-Hydroxy carboxylic acids and derivative amino acids such as Acetylated amino acids.
2. The columns provide excellent resolution operated at room temperature.
3. The columns show high durability.

● USP L32 column

Application data of CRS10W

For all chromatograms, column temperature is room temperature and wave length is 254nm.
All eluents are CuSO₄ aqueous solution except for Fig. 6-9 and Fig. 6-10.

Fig. 6-2 Separation of amino acids mixture

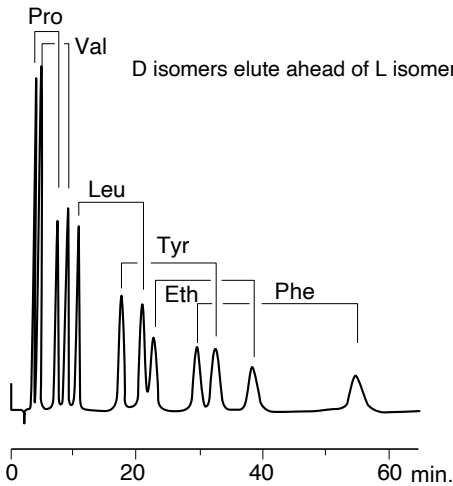

Fig. 6-3 Separation of amino acids mixture

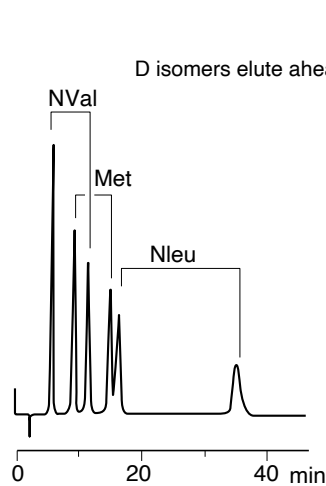

Fig. 6-4 Separation of DL-Ser.

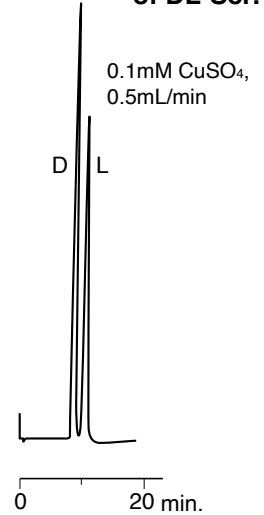

Fig. 6-5 Separation of DL-aspartic acid

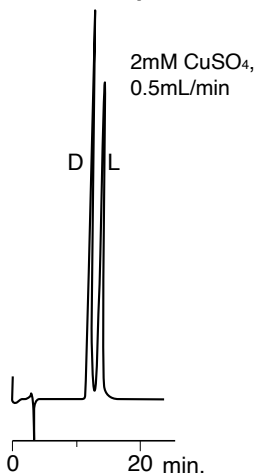

Fig. 6-6 Separation of DL-glutamic acid

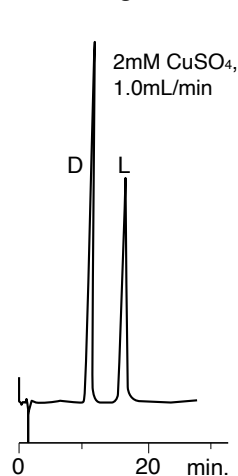

Fig. 6-7 Separation of DL-histidine

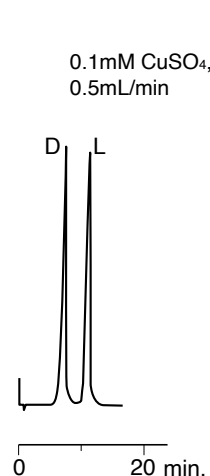

Fig. 6-8 Separation of DL-lysine

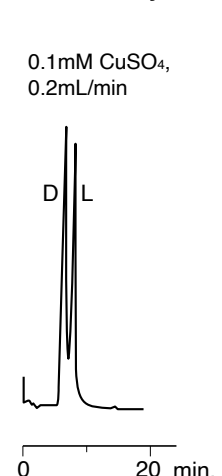

Fig. 6-9 Separation of DL-phenylalanine

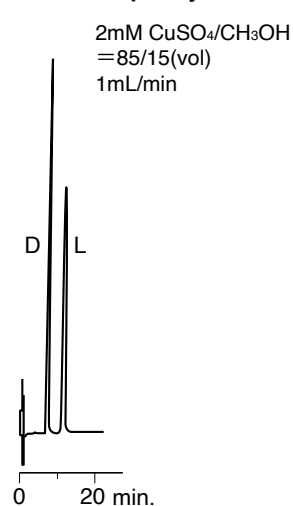

Fig. 6-10 Separation of DL-tryptophan

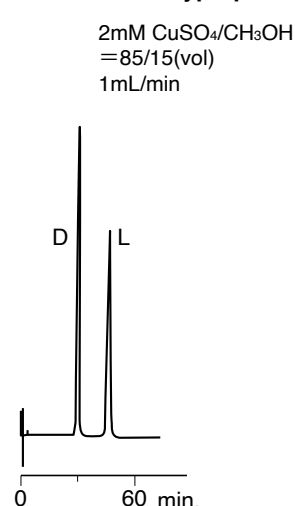

Fig. 6-11 Separation of DL-lactic acid

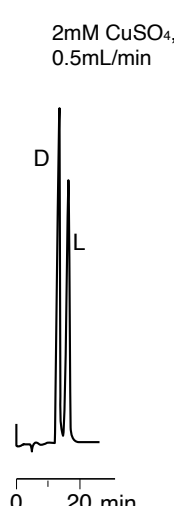
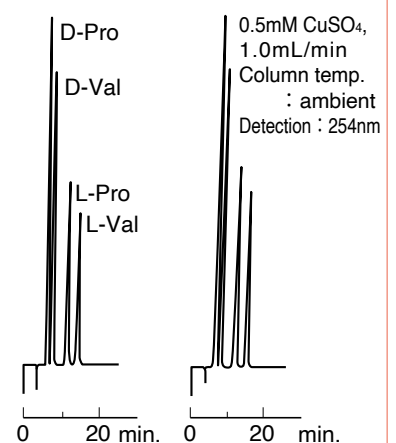

Fig. 6-12 Durability test

The sample was continuously injected 800 times for approximately 500 hrs. Changes of retention times and separation ability are not observed.



Column selection guide
1
Ion exchange columns and materials
2
Ion chromatography columns and materials
3
Bioseparation columns and materials
4
Analytical and preparative chromatography columns and materials for pharmaceutical applications
5
Chiral separation columns
6
SPE sorbent series
7
MCI GEL™ column list
8
MCI GEL™ material list
9
Compounds index
10

Application data of CRS10W

Fig. 6-13 Separation of DL- α -Phenylglycine

Conditions
 Column : MCI GEL™ CRS10W 4.6mm I.D.×50mm
 Eluent : 2mM CuSO₄/CH₃OH=85/15
 Flow rate : 1.0mL/min
 Column temp. : 25°C
 Detection : 254nm
 Sample : 1. D- α -Phenylglycine
 2. L- α -Phenylglycine

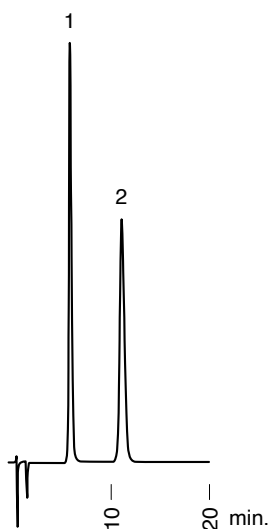

Fig. 6-14 Separation of methionine and acetylmethionine

Conditions
 Column : MCI GEL™ CRS10W 4.6mm I.D.×50mm
 Eluent : 2mM CuSO₄/CH₃CN=90/10
 Flow rate : 1.0mL/min
 Column temp. : 25°C
 Detection : 254nm
 Sample : 1. D-Met
 2. L-Met
 3. Acetyl-D-Met
 4. Acetyl-L-Met

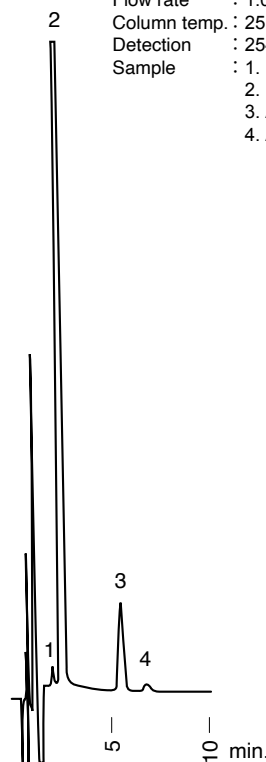

Fig. 6-15 D/L-Aspartic acid

Conditions
 Column : MCI GEL™ CRS10W 4.6mm I.D.×50mm
 Eluent : 0.4mM CuSO₄
 Flow rate : 1.0mL/min
 Temp. : ambient
 Detection : UV 254nm
 Sample : D/L Aspartic acid

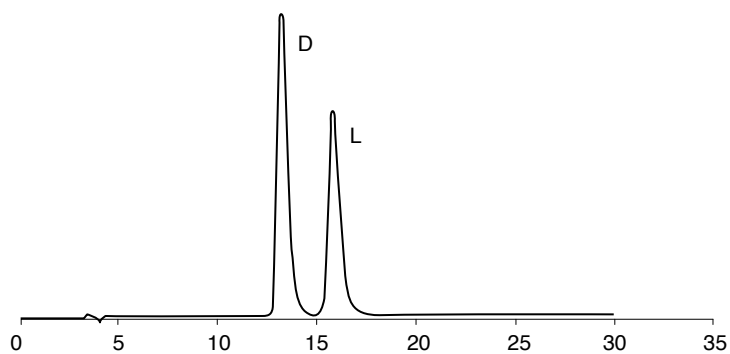
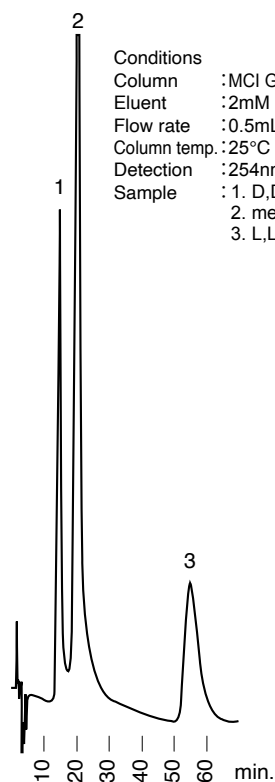

Fig. 6-16 Separation of diaminopimelic acid

Conditions
 Column : MCI GEL™ CRS10W 4.6mm I.D.×50mm
 Eluent : 2mM CuSO₄
 Flow rate : 0.5mL/min
 Column temp. : 25°C
 Detection : 254nm
 Sample : 1. D,D-2,6-Diaminopimelic acid
 2. meso-2,6-Diaminopimelic acid
 3. L,L-2,6-Diaminopimelic acid



Application data of CRS10W

Fig. 6-17 Separation of 2-hydroxy carboxylic acids

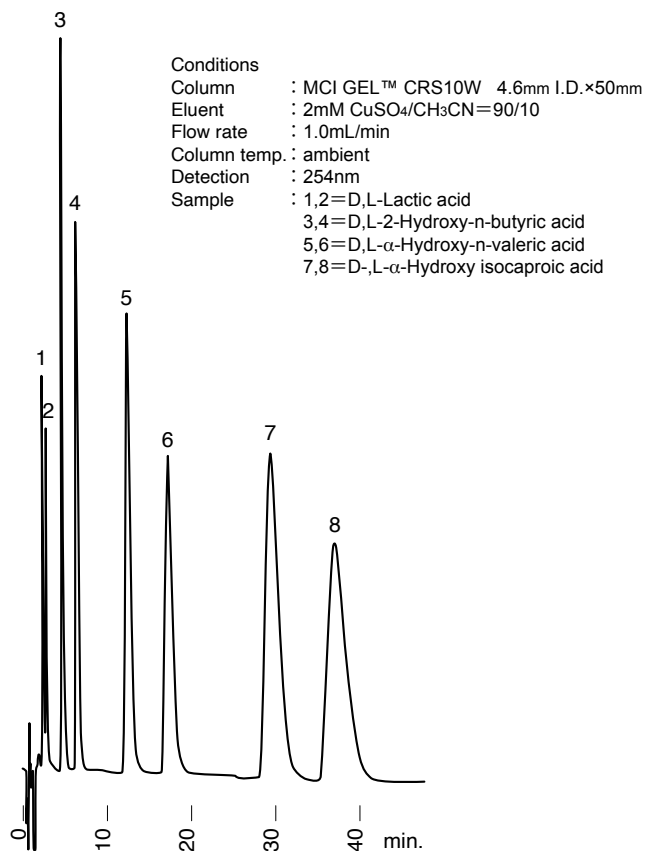

Fig. 6-18 Separation of 2-hydroxy carboxylic acids

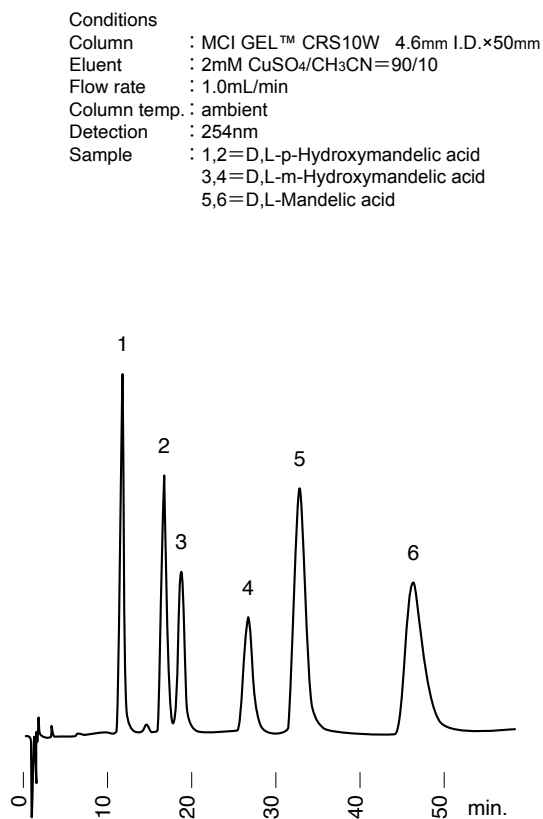

Fig. 6-19 D/L Alanine

Conditions
 Column : MCI GEL™ CRS10W 4.6mm I.D.×50mm
 Eluent : 0.1mM CuSO₄
 Flow rate : 1.0mL/min
 Temp. : 30°C
 Detection : UV 254nm
 Sample : D/L Alanine

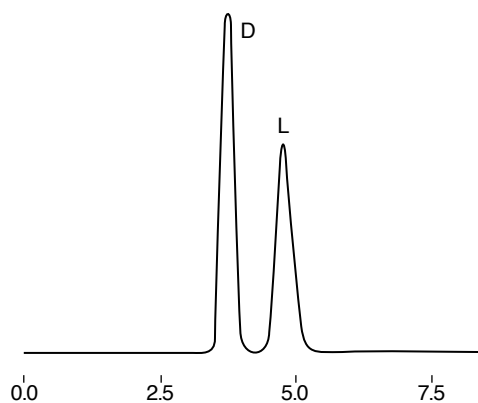
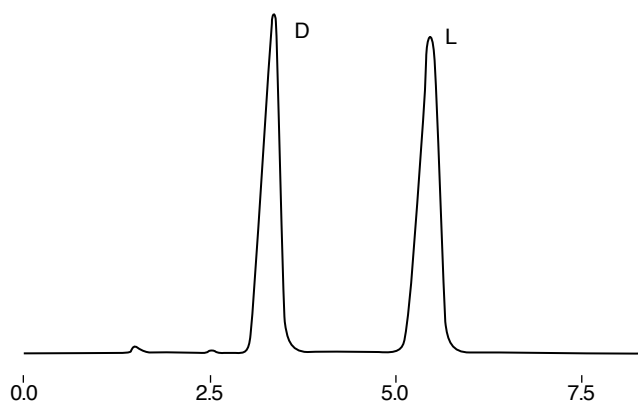

Fig. 6-20 DL-P-Hydroxyphenylglycine

Conditions
 Column : MCI GEL™ CRS10W 4.6mm I.D.×50mm
 Eluent : 2mM CuSO₄:MeOH=85:15
 Flow rate : 1.0mL/min
 Temp. : 30°C
 Detection : UV 254nm
 Sample : DL-P-ydroxyphenylglycine



Comparison data of CRS10W and CRS15W

Fig. 6-21 Separation of DL-alanine

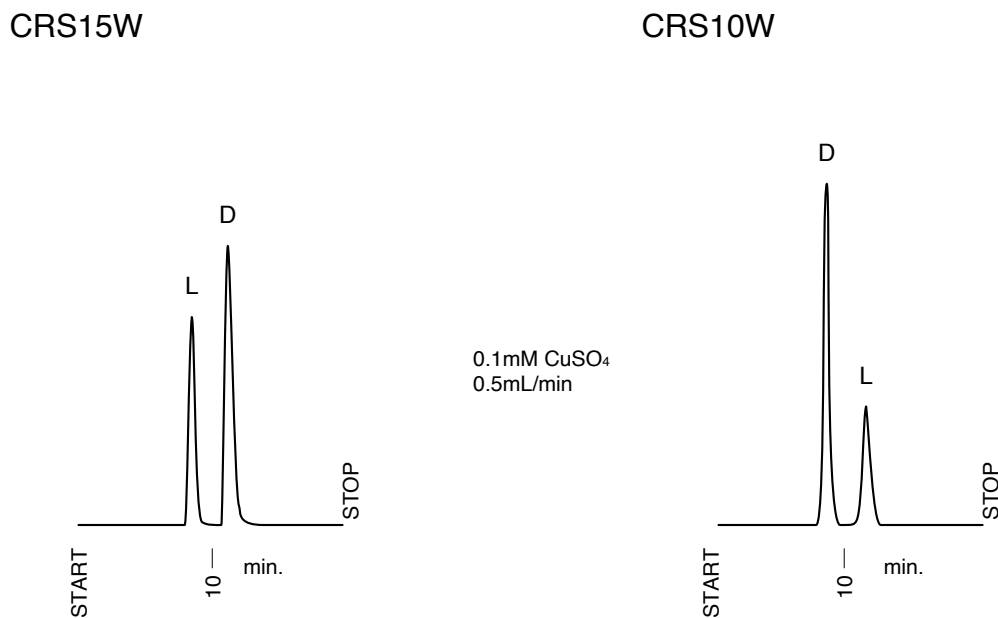
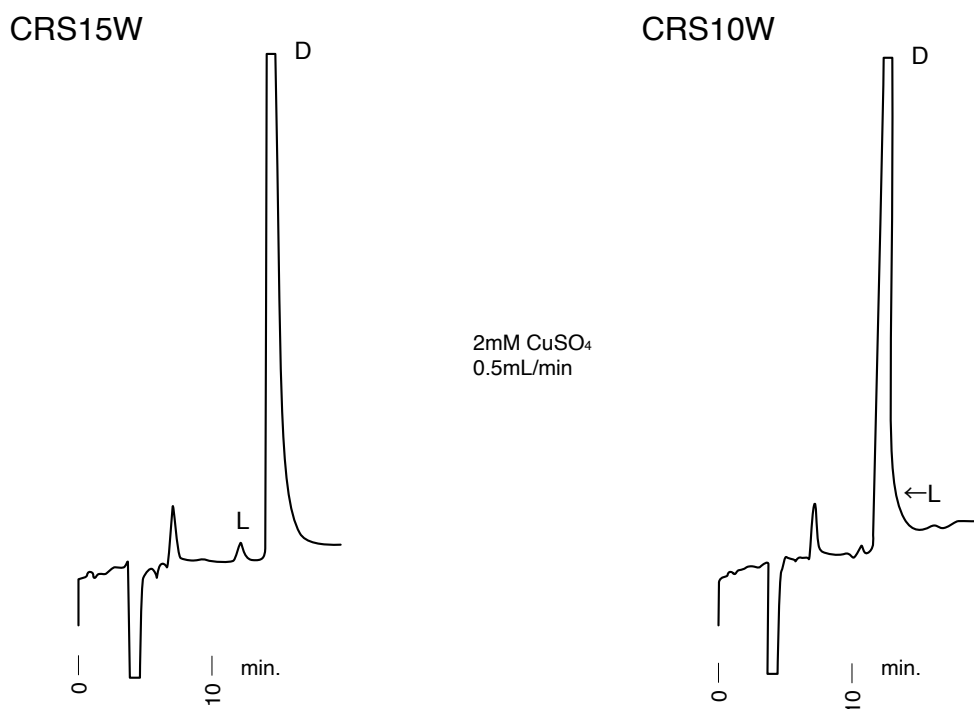

Fig. 6-22 Analysis of a trace of L-lactic acid in 50 ppm D-lactic acid

The CRS15W is recommended for analysis of a trace of L-isomer in a principal D-isomer when the CRS10W does not provide an adequate chromatogram.



Examples of chromatographic conditions and datas

	Amino acids	CuSO ₄ aq. soln. [mM]	Flow rate [mL/min]	Retention time; L-isomers [min]	Separation factor [α]	Separation rate [Rs]
1	Orn•HCl	0.1	0.2	6.8	1.26	<1
2	Lys•HCl	0.1	0.2	7.7	1.45	<1
3	Ala	0.1	0.5	11.0	1.39	1.4
4	His•HCl	0.1	0.5	10.5	1.63	1.7
5	Ser	0.1	0.5	10.1	1.25	1.0
6	Thr	0.1	0.5	11.3	1.29	1.3
7	Cit	0.5	0.5	10.4	1.75	2.3
8	Hyp	1.0	0.2	23.8	1.23	1.1
9	Pro	1.0	1.0	7.3	2.13	4.5
10	Val	1.0	1.0	8.9	2.04	5.0
11	Nval	1.0	1.0	11.5	2.07	4.7
12	Asp	2.0	0.5	13.2	1.18	0.8
13	Glu	2.0	1.0	16.2	1.54	2.3
14	Ileu(DL)	2.0	0.5	30.4	2.14	6.5
15	Ileu(allo)	2.0	0.5	21.9	1.97	6.0
16	Leu	2.0	1.0	14.6	1.97	4.6
17	Nleu	2.0	1.0	24.1	2.16	6.5
18	Met	2.0	1.0	10.3	1.64	2.6
19	Tyr	2.0	1.0	22.5	1.85	5.3
20	Eth	2.0	1.0	26.4	1.69	5.0
21	Phe	2.0	1.0	37.8	1.84	6.3

1. Column temperature; ambient Detection; 254nm
2. These are example data and do not guarantee the column specifications.
3. Improved resolution or appropriate chromatogram can be obtained by further investigating chromatographic conditions.
4. For each amino acid in the table, D-isomer elutes ahead of L-isomer except for Hydroxyproline.

Notes

1. It will take hours for equilibrium between ligand of stationary phase and copper ion of eluent. Two to three hours of conditioning the column with the eluent is advised before sample injection or after changing concentration of CuSO₄ of eluent.
2. For acidic amino acids, higher CuSO₄ concentration of eluent provides better resolution.
3. For weakly retained hydrophilic amino acids, low flow rate (0.2-0.5 mL/min) yields better resolution.
4. Peak area may decrease with continuous injection of samples, when the concentration of amino acids in sample solution is much higher than that of CuSO₄ in the eluent.
5. Please be careful not to flow both water soluble organic solvents (CH₃CN, CH₃OH, etc) and non water soluble organic solvents (n-hexane, chloroform, etc) into the column. The column will be fatally damaged and will never separate optical isomers. Please be particularly careful if HPLC equipment is used together with RP mode and NP mode.
6. Please do not use acid or alkali solutions to adjust pH of eluent. And also do not use buffer solutions. These solutions may cause forming precipitation, hence cause of blockage of the column.
7. For strongly retained hydrophobic amino acids, addition of CH₃CN or CH₃OH in the eluent enables faster elution. The concentration of these organic solvents should be below 15 v/v%.
8. DOPA and other non-polar amino acids will be strongly adsorbed on the packing material and will cause contamination of the column.
9. Regeneration of contaminated column is difficult.

For a pretreatment of analytical sample, we provide various SPE sorbents with various chemical structure, hydrophobicity, and micro-pore sizes. You can select our SPE sorbents depending on your molecule nature.

- CHP85/P120, CHP87/P120, CHPOD/P30: SPE sorbents with a controlled micro-pore size, high performance small molecule adsorption except large molecule mixture, like proteins.
- CSP800: SPE sorbents with high concentration ratio and high recovery, excellent for enrichment trace organic compounds and non-ionic substances such as trichloroethylene from environmental water. These SPE sorbents are to prepare samples for mutagenicity study or GC/MS analysis.
- SFP08/P25: SPE sorbents dedicated for small drug molecules extraction. Superior purity of this SPE extracts offers easier and faster sample preparation.
- CHL10P, CHL20P, CLB20P: SPE sorbents for rare earth metals that contains chelating functional group. CLB10P: SPE sorbents for borate, arsenic and selenium ions that contains glucamine groups on high porous ST/DVB matrix.

Material list

● Synthetic adsorbents and reversed-phase materials

Name	Particle size [μm]	Pore size	Surface area [m ² /g]	pH range	Typical Application
CHP85/P120	120	middle	880-940	full range	Small molecules extraction
CHP87/P120	120	small	820-910	full range	
CHPOD/P30	30	large	340-380	2~12	
CSP800	120	middle	790-920	full range	Enrichment of trace of organic compounds
SFP08/P25	25	middle	>1000	full range	Small molecules extraction

● Chelating type

Name	Functional group	Particle size [μm]	Ion exchange capacity [meq/mL]	Effective pH range	Typical Application
CHL10P	Iminodiacetic acid	120	>1.5	2-6	Metal Extraction
CHL20P	Polyamine	120	>1.8	2-6	Metal Extraction
CLB10P	Glucamine	120	>1.0	>3	Extraction Bron Removal

8

MCI GEL™

MCI GEL™ column list

Main column				Guard/Pre-column						
Code No.	Name	Column dimensions [mm]	USP	Code No.	Name	Column dimensions [mm]				
Ion exchange chromatography cation exchange resin for amino acids				0-019-01	CK10U	6×120	0-033-21	AFR2-PC	6×50	
Ion exchange chromatography cation exchange resin for sugars				0-009-01	CK08S	8×500	L58	0-009-11	CK08SG	6×50
				0-010-01	CK08E	8×300	L58	0-010-11	CK08EG	6×50
				0-010-06		7.8×300		0-010-12	CK08ECG	6×50
				0-010-02	CK08EC	8×300	L19			
				0-010-07		7.8×300				
Ion exchange chromatography cation exchange resin for carboxylic acids				0-010-05	CK08EH	8×300	L17	0-010-15	CK08EHG	6×50
				0-010-08		7.8×300				
Ion exchange chromatography cation exchange resin for oligosaccharides				0-001-01	CK02A	20×250	L58	0-001-11	CK02AG	8×10
				0-001-02	CK02AS	20×250		0-001-12	CK02ASG	8×10
				0-003-01	CK04S	10×200	L58	0-017-11	CK10SG	6×50
								0-003-11	CK04SG	8×10
				0-003-02	CK04SS	10×200		0-017-11	CK10SG	6×50
								0-003-12	CK04SSG	8×10
Ion exchange chromatography anion exchange resin for carboxylic acids and sugars				0-111-01	CA08F	4.6×250		0-111-11	CA08FG	4×10
Ion chromatography for cations				0-034-01	SCK01	6×50		0-034-21	SCK-PC	6×50
				0-034-04	SCK01	4.6×150				
				0-407-01	CHK45/C05	4.6×150				
Ion chromatography for anions				0-133-02	SCA04/PEEK	4.6×150	L31	0-133-12	SCA04G	4.6×30
								0-130-22	SCA-PC	8×10
Bioseparation for size exclusion				0-213-01	CQP06	7.5×600	L25	0-213-11	CQP06G	4×50
				0-214-01	CQP10	7.5×600	L38	0-214-11	CQP10G	4×50
				0-215-01	CQP30	7.5×600	L37, 38	0-215-11	CQP30G	4×50

Main column				Main column			
Code No.	Name	Column dimensions [mm]	USP	Code No.	Name	Column dimensions [mm]	USP
Analytical and preparative chromatography columns for pharmaceutical applications [CHP column series]							
0-401-05	CHP20/C04	4.6X150	L21				
0-401-03	CHP20/C04	20X150	L21				
0-403-05	CHP20/C10	4.6X150	L21				
0-403-01	CHP20/C10	4.6X250	L21				
0-403-02	CHP20/C10	10X250	L21				
0-403-03	CHP20/C10	20X150	L21				
0-403-04	CHP20/C10	20X250	L21				
0-405-01	CHP07/C04	4.6X150					
0-405-04	CHP07/C04	20X200					
0-405-05	CHP07/C10	4.6X150					
0-406-01	CHP07/C10	4.6X250					
0-406-02	CHP07/C10	10X150					
0-406-03	CHP07/C10	20X150					
0-406-04	CHP07/C10	20X250					
0-402-05	CMG20/C04	4.6X150	L39				
0-402-03	CMG20/C04	20X150	L39				
0-202-06	CMG20/C10	4.6X150	L39				
0-202-05	CMG20/C10	4.6X250	L39				
0-202-02	CMG20/C10	10X250	L39				
0-202-03	CMG20/C10	20X150	L39				
0-202-04	CMG20/C10	20X250	L39				
0-404-01	CHK40/C04	4.6X150					
0-407-01	CHK45/C05	4.6X150					
0-504-01	CHPOD/C04	4.6X150					
0-504-04	CHPOD/C04	20X200					
XtalSpeed™ series							
0-047-01	DA01	4.6X50					
0-047-04	DA01	4.6X100					
0-047-02	DA01	7.5X100					
0-047-03	DA01	11.5X100					
0-047-11	SP01	4.6X50					
0-047-12	SP01	4.6X100					
0-047-13	SP01	7.5X100					
0-047-14	SP01	11.5X100					

Characteristics

1. Excellent performance

Sphere packing and sharp particle size distribution provide high performance.

2. Persistence and highest quality

Produced with Mitsubishi Chemical's excellent technology, experience and under strict quality control.

3. Wide range of product line

MCI GEL™ packing materials include ion exchange resins (cation and anion), non-functionalized polymer used for reversed phase chromatography and other varieties of products. Also MCI GEL™ offers particle size of 4 μm to approximately 120 μm packing materials, this means that MCI GEL™ products are applied to analysis use and preparative use.

4. Abundant experience

Mitsubishi Chemical has been supplying packing materials for more than 50 years.

● Ion exchange chromatography cation exchange resins [CK series, AFR series]

Code No.	Name	Packing size [g]	Base material	Functional group	Counter ion	Particle size [μm]	Cross linkage [%]	Ion exchange capacity [meq/g]	Typical Application
1-001-01	CK02A	10	ST/DVB	RSO ₃ ⁻	Na ⁺	20	2	>4.5	Oligosaccharides
1-003-01	CK04S	10	ST/DVB	RSO ₃ ⁻	Na ⁺	11	4	>4.5	Oligosaccharides
1-003-02	CK04S	25							
1-003-03	CK04S	50							
1-004-01	CK06S	10	ST/DVB	RSO ₃ ⁻	Na ⁺	11	6	>4.45	Oligosaccharides
1-004-02	CK06S	25							
1-004-03	CK06S	50							
1-009-01	CK08S	10	ST/DVB	RSO ₃ ⁻	Na ⁺	11	8	>4.40	Sugars, Carboxylic acids
1-009-02	CK08S	25							
1-009-03	CK08S	50							
1-010-01	CK08E	10	ST/DVB	RSO ₃ ⁻	Na ⁺	9	8	>4.40	Sugars, Carboxylic acids
1-010-02	CK08E	25							
1-010-03	CK08E	50							
1-013-01	CK08Y	50	ST/DVB	RSO ₃ ⁻	Na ⁺	25	8	>4.40	Sugars, Carboxylic acids
1-013-02	CK08Y	300							
1-014-01	CK08P	100 mL	ST/DVB	RSO ₃ ⁻	H ⁺	120	8	>1.8 (meq/mL)	Sugars, Carboxylic acids
1-017-01	CK10S	10	ST/DVB	RSO ₃ ⁻	Na ⁺	11	10	>4.3	Carboxylic acids, Amino acids
1-017-02	CK10S	25							
1-017-03	CK10S	50							
1-018-01	CK10F	5	ST/DVB	RSO ₃ ⁻	Na ⁺	7	10	>4.3	Amino acids
1-018-02	CK10F	10							
1-019-01	CK10U	3	ST/DVB	RSO ₃ ⁻	Na ⁺	5	10	>4.3	Amino acids
1-019-03	CK10U	5							
1-019-04	CK10U	10							
1-020-05	CK10M	5	ST/DVB	RSO ₃ ⁻	Na ⁺	4	10	>4.3	Amino acids
1-020-06	CK10M	3							
1-024-02	CK12U	5	ST/DVB	RSO ₃ ⁻	Na ⁺	5	12	>4.3	Amino acids
1-021-01	CK10Y	50	ST/DVB	RSO ₃ ⁻	Na ⁺	25	10	>4.3	Amino acids
1-033-01	AFR2	5	ST/DVB	RSO ₃ ⁻	H ⁺	25	-	>2.7	Ammonia trap

Abbreviation; ST/DVB = Styrene-divinylbenzene copolymer

● Ion exchange chromatography anion exchange resins [CA series]

Code No.	Name	Packing size [g]	Base material	Functional group	Counter ion	Particle size [μm]	Cross linkage [%]	Ion exchange capacity [meq/mL]	Typical Application
1-104-01	CA06S	10	ST/DVB	QA	Cl ⁻	11	6	>1.2	Sugars, Carboxylic acids
1-104-02	CA06S	25							
1-104-03	CA06S	50							
1-106-01	CA06Y	50	ST/DVB	QA	Cl ⁻	25	6	>1.2	Sugars, Carboxylic acids
1-109-01	CA08S	10	ST/DVB	QA	Cl ⁻	11	8	>1.2	Sugars, Carboxylic acids
1-109-02	CA08S	25							
1-109-03	CA08S	50							
1-111-01	CA08F	5	ST/DVB	QA	Cl ⁻	7	8	>1.2	Sugars, Carboxylic acids
1-111-02	CA08F	10							
1-112-01	CA08Y	50	ST/DVB	QA	Cl ⁻	25	8	>1.2	Sugars, Carboxylic acids
1-113-01	CA08P	100 mL	ST/DVB	QA	Cl ⁻	120	8	>1.3	Sugars, Carboxylic acids
1-116-01	CA10S	10	ST/DVB	QA	Cl ⁻	11	10	>1.2	Sugars, Carboxylic acids
1-116-02	CA10S	25							
1-116-03	CA10S	50							
1-117-01	CA10Y	50	ST/DVB	QA	Cl ⁻	25	10	>1.2	Sugars, Carboxylic acids

Abbreviations ; ST/DVB=styrene-divinyl benzene copolymer QA ; Quaternary ammonium

● Ion chromatography materials [SCA, SCK series]

Code No.	Name	Packing size [g]	Base material	Functional group	Counter ion	Particle size [μm]	Ion exchange capacity [μeq/g]	Typical Application
1-034-01	SCK01	5	ST/DVB	RSO ₃ ⁻	H ⁺	11	25	Cation analysis
1-034-02	SCK01	10						
1-133-01	SCA04	5	HMA	QA	Cl ⁻	5	30	Anion analysis
1-133-02	SCA04	10						

Abbreviations; ST/DVB = Styrene-divinylbenzene copolymer HMA = Polyhydroxymethacrylate QA = Quaternary ammonium

● Bioseparation columns -Size exclusion chromatography materials- [CQP series]

Code No.	Name	Packing size [g]	Base material	Particle size [μm]	Pore size [nm]	Exclusion limit	Typical Application
1-213-01	CQP06	10	HMA	10	12	1×10 ³	Water soluble polymer
1-213-02	CQP06	25					
1-213-03	CQP06	50					
1-214-01	CQP10	10	HMA	10	20	1×10 ⁴	Water soluble polymer
1-214-02	CQP10	25					
1-214-03	CQP10	50					
1-215-01	CQP30	10	HMA	10	60	1×10 ⁶	Water soluble polymer
1-215-02	CQP30	25					
1-215-03	CQP30	50					
1-222-01	CQP30P	100 mL	HMA	30	60	1×10 ⁶	Water soluble polymer

Abbreviation; HMA = Polyhydroxymethacrylate

● Analytical and preparative chromatography materials for pharmaceutical applications [CHP material series]

Code No.	Product Name	Packing size [mL]	Base material	Particle size [μm]	Pore size [nm]	pH range	Typical Application
1-307-06	CHP20/P20	25	ST/DVB	20	45	full range	Reversed-phase chromatography
1-307-07	CHP20/P20	100					
1-307-08	CHP20/P20	1,000					
1-305-06	CHP20/P30	25	ST/DVB	30	45	full range	Reversed-phase chromatography
1-305-07	CHP20/P30	100					
1-305-08	CHP20/P30	1,000					
1-310-01	CHP20/P50	100g	ST/DVB	50	45	full range	Reversed-phase chromatography
1-313-02	CHP20/P70	500					
1-313-03	CHP20/P70	1,000					
1-313-04	CHP20/P70	10,000					
1-311-01	CHP20/P120	100	ST/DVB	120	45	full range	Reversed-phase chromatography
1-311-02	CHP20/P120	500					
1-311-03	CHP20/P120	1,000					
1-311-04	CHP20/P120	10,000					
1-311-05	CHP20/P120	50,000					
1-304-06	CHP50/P20	25	ST/DVB	20	25	full range	Reversed-phase chromatography
1-304-07	CHP50/P20	100					
1-304-08	CHP50/P20	1,000					
1-303-06	CHP50/P30	25	ST/DVB	30	25	full range	Reversed-phase chromatography
1-303-07	CHP50/P30	100					
1-303-08	CHP50/P30	1,000					
1-312-01	CSP50/P10	10g	ST/DVB	10	25	full range	Reversed-phase chromatography
1-312-03	CSP50/P10	1,000					
1-314-02	CHP07/P120	100	ST/DVB	120	25	full range	Reversed-phase chromatography
1-314-03	CHP07/P120	1,000					
1-314-04	CHP07/P120	10,000					
1-314-05	CHP07/P120	50,000					
1-309-01	CMG20/P10	10g	MA	10	25	2~12	Reversed-phase chromatography
1-309-03	CMG20/P10	1,000					
1-306-06	CMG20/P30	25	MA	30	25	2~12	Reversed-phase chromatography
1-306-07	CMG20/P30	100					
1-306-08	CMG20/P30	1,000					

Abbreviations; MA=Polymethacrylate ST/DVB=Styrene-divinylbenzene copolymer

● Synthetic adsorbent and reversed-phase materials

Code No.	Product Name	Packing size	Particle size [μm]	Pore size	pH range	Typical Application
1-315-02	CHP85/P120	100mL	120	Middle Small Large	Full range	Small molecules extraction
1-316-02	CHP87/P120	100mL	120			
1-505-02	CHPOD/P30	100g	30			
1-219-01	CSP800	50mL	120	Middle	Full range	Enrichment of trace of organic compounds
1-317-01	SFP08/P25	50g	25	Middle	Full range	Small molecules extraction

● Chelating resins for solid phase extraction in pretreatment

Code No.	Product Name	Packing size [g]	Functional group	Particle size [μm]	Exchange capacity [meq/mL]	Typical Application
1-601-02	CHL10P	100	Iminodiacetic acid	120	> 1.5	Metal Extraction
1-602-02	CHL20P	100	Polyamine	120	> 1.8	Metal Extraction
1-603-02	CLB10P	100	Glucamine	120	> 1.0	Bron Removal

10

MCI GEL™

Compounds index

Compound	Classification	MCI GEL™ column	Figure	Page
Acetic acid	Acetic acid	CK08EH	2-13	11
Acetic acid	Acetic acid	CK08EH	2-16	12
Acetic acid	Acetic acid	CK08EH	2-18	12
Acetic acid	Acetic acid	CA08F	2-39	19
Acetic acid	Acetic acid	CA08F	2-40	20
Acetic acid	Acetic acid	CA08F	2-41	20
Acetic acid	Acetic acid	CA08F	2-42	20
N-Acetylgalactosamine	N-Acetylgalactosamine	CK08EH	2-14	11
N-Acetylglucosamine	N-Acetylglucosamine	CK08EH	2-14	11
Acetyl-D-Met.	Acetyl-D-Met.	CRS10W	6-14	54
Acetyl-L-Met.	Acetyl-L-Met.	CRS10W	6-14	54
Adenine	Nucleic base	CHK40/C04	5-25	43
Adenine	Nucleic base	CHK45/C05	5-33	46
Adenosine	Nucleoside	SCK01	3-6	22
Adenosine	Nucleoside	CHK40/C04	5-25	43
Adenosine	Nucleoside	CHK45/C05	5-33	46
Adonitol	Adonitol	CK08EC	2-1	7
Alanine	Alanine	CK10U	2-32	17
Alanine	Amino acid	CK10U	2-36	18
β-Alanine	β-Alanine	CK10U	2-33	18
D-Alanine	D-Alanine	CRS10W/CRS15W	6-21	56
D-Alanine	D-Amino acid	CRS10W	6-19	55
L-Alanine	L-Alanine	CRS10W/CRS15W	6-21	56
L-Alanine	L-Amino acid	CRS10W	6-19	55
γ-Aminobutyric acid	γ-Aminobutyric acid	CK10U	2-34	18
6-Aminopenicillanic acid	6-Aminopenicillanic acid	CHP50/P20	5-35	48
Ammonia	Ammonia	SCK01	3-2	22
Ammonium ion	Cation	SCK01	3-1	22
Ammonium ion	Cation	SCK01	3-3	22
Ammonium ion	Cation	CHK45/C05	3-10	23
AMP	Nucleotide	CHK45/C05	5-33	46
Amphotericin B	Amphotericin B	CHP20/C10	5-17	39
Angiotensin II	Angiotensin II	CMG20/C04	5-12	38
Antipyrine	Antipyrine	CMG20/C04	5-10	37
Arginine	Arginine	CK10U	2-32	17
Ascorbic acid	Carboxylic acid	CA08F	2-41	20
Aspartic acid	Aspartic acid	CK10U	2-32	17
D-Aspartic acid	D-Aspartic acid	CRS10W	6-5	53
D-Aspartic acid	D-Amino acid	CRS10W	6-15	54
L-Aspartic acid	L-Aspartic acid	CRS10W	6-5	53
L-Aspartic acid	L-Amino acid	CRS10W	6-15	54
Aspirin	Aspirin	CMG20/C04	5-10	37
Barium ion	Barium ion	SCK01	3-7	23
Bromide ion	Bromide ion	SCA04	3-11	24
Bromide ion	Bromide ion	SCA04	3-12	24
Buserelin	Buserelin	CHP20/C10	5-22	42
Buserelin	Buserelin	CMG20/C10	5-22	42
n-Butyl alcohol	n-Butyl alcohol	CK08EH	2-15	11
sec-Butyl alcohol	sec-Butyl alcohol	CK08EH	2-15	11
Cadmium ion	Cadmium ion	SCK01	3-8	23
Caffeine	Caffeine	CHP20/C04	5-4	34
Caffeine	Caffeine	CMG20/C04	5-10	37
Caffeine	Caffeine	CHP50/P20	5-36	48
Calcium ion	Calcium ion	SCK01	3-7	23
Calcium ion	Calcium ion	SCK01	3-8	23
Calcium ion	Calcium ion	SCK01	3-9	23
Calcium ion	Cation	CHK45/C05	3-10	23
Candesartan	Candesartan	CHK40/C04	5-28	45
Capsaicin	Alkaloid	CMG20/C10	5-40	50
Carbonate ion	Carbonate ion	SCA04	3-14	25

Compound	Classification	MCI GEL™ column	Figure	Page
Catechin	Catechin	CHP50/P20	5-36	48
Cellobiose	Cellobiose	CA08F	2-38	19
Cellobiose	Cellobiose	CDR10	2-45	22
Cesium ion	Cation	SCK01	3-1	22
Chloride ion	Anion	SCA04	3-11	24
Chloride ion	Anion	SCA04	3-12	24
Chloride ion	Anion	SCA04	3-13	24
Chloride ion	Anion	SCA04	3-14	25
Chloride ion	Anion	SCA04	3-16	25
Chloroacetic acid	Carboxylic acid	CK08EH	2-16	12
Chloroacetic acid	Carboxylic acid	CK08EH	2-18	12
Cholic acid	Bile acid	CHP20/C04	5-7	35
α-Chymotrypsinogen A	Protein	CMG20/C04	5-13	38
α-Chymotrypsinogen A	Protein	CMG20/C10	5-18	40
Cinchonine	Cinchona alkaloid	CHP20/C04	5-5	34
Citric acid	Carboxylic acid	CK08EH	2-13	11
Citric acid	Carboxylic acid	CA08F	2-39	19
Citric acid	Carboxylic acid	CA08F	2-40	20
Cobalt ion	Cation	SCK01	3-8	23
Conalbumin	Protein	CHP20/C10	5-19	40
Corticosterone	Adrenal cortical hormone	CHP20/C04	5-9	36
Crocin	Crocin	CMG20/P30	5-39	50
Cystine	Amino acid	CK10U	2-32	17
Cytidine	Nucleoside	SCK01	3-6	22
Cytidine	Nucleoside	CHK40/C04	5-25	43
Cytidine	Nucleoside	CHK45/C05	5-33	46
Cytosine	Nucleic base	CHK40/C04	5-25	43
Cytosine	Nucleic base	CHK45/C05	5-33	46
Cytochrome c	Protein	CQP30	4-6	30
Cytochrome c	Protein	CMG20/C04	5-13	38
Cytochrome c	Protein	CMG20/C10	5-18	40
β-Citronellol	Perfume	CMG20/C10	5-26	44
Deoxycholic acid	Bile acid	CHP20/C04	5-7	35
11-Deoxycortisol	Adrenal cortical hormone	CHP20/C04	5-9	36
Deoxyribose	Deoxysugar	CA08F	2-38	19
D,D-2,6-Diaminopimelic acid	D,D-Diamino carboxylic acid	CRS10W	6-16	54
L,L-2,6-Diaminopimelic acid	L,L-Diamino carboxylic acid	CRS10W	6-16	54
meso-2,6-Diaminopimelic acid	meso-Diamino carboxylic acid	CRS10W	6-16	54
Dibutyl phthalate	Aromatic ester	CHP50/P20	5-34	48
Dichloroacetic acid	Carboxylic acid	CK08EH	2-16	12
Dichloroacetic acid	Carboxylic acid	CK08EH	2-18	12
Diethylene glycol	Polyalcohol	CK08EH	2-17	12
Diethyl phthalate	Aromatic ester	CHP20/C04	5-3	34
Dihydrocapsaicin	Alkaloid	CMG20/C10	5-40	50
Dimethylamine	Amine	SCK01	3-2	22
4-Dimethylaminoantipyrine	Medicine	CMG20/C04	5-10	37
Dimethyl phthalate	Aromatic ester	CHP20/C04	5-3	34
Dimethyl phthalate	Aromatic ester	CHP50/P20	5-34	48
Dipropyl phthalate	Aromatic ester	CHP20/C04	5-3	34
Dipropyl phthalate	Aromatic ester	CHP50/P20	5-34	48
Dopamine	Catecholamine	CHP20/C04	5-2	34
Epicatechin	Catechol	CHP50/P20	5-36	48
Epicatechin gallate	Catechol	CHP50/P20	5-36	48
Epigallocatechin	Catechol	CHP50/P20	5-36	48
Epigallocatechin gallate	Catechol	CHP50/P20	5-36	48
Epinephrine	Catecholamine	CHP20/C04	5-2	34
Erythritol	Sugar alcohol	CK08EC	2-8	8
Erythritol	Sugar alcohol	CK08EC	2-9	9
Erythritol	Sugar alcohol	CK08EC	2-10	9
meso-Erythritol	Sugar alcohol	CK08EC	2-1	7
D-Ethionine	D-Amino acid	CRS10W	6-2	53
L-Ethionine	L-Amino acid	CRS10W	6-2	53
Ethyl alcohol	Alcohol	CK08EC	2-8	8
Ethyl alcohol	Alcohol	CK08EH	2-15	11
Ethyl alcohol	Alcohol	CK08EC	2-9	9

Compound	Classification	MCI GEL™ column	Figure	Page
Ethylene glycol	Polyalcohol	CK08EH	2-15	11
Ethylene glycol	Polyalcohol	CK08EH	2-17	12
Ferritin	Protein	CQP30	4-6	30
Filipin	Antibiotic	CHP20/C10	5-17	39
Fluoride ion	Anion	SCA04	3-11	24
Fluoride ion	Anion	SCA04	3-12	24
Formic acid	Carboxylic acid	CK08EH	2-13	11
Formic acid	Carboxylic acid	CA08F	2-39	19
Formic acid	Carboxylic acid	CA08F	2-41	20
Fructose	Sugar	CK08EC	2-1	7
Fructose	Sugar	CK08EC	2-2	7
Fructose	Sugar	CK08EC	2-4	8
Fructose	Sugar	CK08EC	2-5	8
Fructose	Sugar	CK08EC	2-6	8
Fructose	Sugar	CK08EC	2-7	8
Fructose	Sugar	CK08EC	2-8	8
Fructose	Sugar	CK08EC	2-9	9
Fructose	Sugar	CK08EC	2-10	9
Fructose	Sugar	CK08EC	2-11	10
Fructose	Sugar	CK04S	2-28	16
Fructose	Sugar	CK04S	2-29	16
Fructose	Sugar	CK04S	2-30	16
Fructose	Sugar	CA08F	2-38	19
Fructo-oligosaccharide	Fructo-oligosaccharide	CK04S	2-30	16
Fucose	Sugar	CA08F	2-38	19
Galactose	Sugar	CK08EC	2-3	7
Galactose	Sugar	CK08EC	2-11	10
Galactose	Sugar	CK06SC	2-19	12
Galactose	Sugar	CA08F	2-38	19
Gallocatechin	Catechol	CHP50/P20	5-36	48
GDP	Nucleotide	CHK45/C05	5-33	46
Gentiobiose	Disaccharide	CK08EC	2-1	7
Gentiobiose	Disaccharide	CK08EC	2-10	9
Geraniol	Perfume	CMG20/C10	5-26	44
Ghrelin human	Peptide	CMG20/C10	5-21	41
Ghrelin rat	Peptide	CMG20/C10	5-21	41
Gluconic acid	Carboxylic acid	CA08F	2-40	20
Gluconic acid	Carboxylic acid	CA08F	2-42	20
Gluconic acid	Carboxylic acid	CQP06	4-7	30
Glucose	Sugar	CK08EC	2-1	7
Glucose	Sugar	CK08EC	2-2	7
Glucose	Sugar	CK08EC	2-4	8
Glucose	Sugar	CK08EC	2-5	8
Glucose	Sugar	CK08EC	2-6	8
Glucose	Sugar	CK08EC	2-7	8
Glucose	Sugar	CK08EC	2-8	8
Glucose	Sugar	CK08EC	2-9	9
Glucose	Sugar	CK08EC	2-10	9
Glucose	Sugar	CK08E	2-12	10
Glucose	Sugar	CK08EH	2-14	11
Glucose	Sugar	CK04S	2-28	16
Glucose	Sugar	CK04S	2-29	16
Glucose	Sugar	CK04S	2-30	16
Glucose	Sugar	CA08F	2-38	19
Glucose	Sugar	CQP06	4-7	30
Glutamic acid	Amino acid	CK10U	2-32	17
D-Glutamic acid	D-Amino acid	CRS10W	6-6	53
L-Glutamic acid	L-Amino acid	CRS10W	6-6	53
Glycerol	Polyalcohol	CK08EC	2-8	8
Glycerol	Polyalcohol	CK08EC	2-9	9
Glycerol	Polyalcohol	CK08EH	2-15	11
Glycine	Amino acid	CK10U	2-32	17
Glycolic acid	Carboxylic acid	CK08EH	2-13	11
Glycolic acid	Carboxylic acid	CK08EH	2-18	12
Glycyrrhizic acid	Glycyrrhizic acid	CHP20/C04	5-8	36

Compound	Classification	MCI GEL™ column	Figure	Page
Gly-Tyr	Peptide	CMG20/C04	5-12	38
Guanosine	Nucleoside	SCK01	3-6	22
Guanosine	Nucleoside	CHK40/C04	5-25	43
Guanosine	Nucleoside	CHK40/C04	5-25	43
Guanosine	Nucleoside	CHK45/C05	5-33	46
Guanosine	Nucleoside	CHK45/C05	5-33	46
Histidine	Amino acid	CK10U	2-32	17
D-Histidine	D-Amino acid	CRS10W	6-7	53
L-Histidine	L-Amino acid	CRS10W	6-7	53
Hemoglobin A0	Protein	SP01	4-2	28
Hemoglobin A1c	Protein	SP01	4-2	28
5-HPA	Amino acid	CK10U	2-35	18
Hydrocortisone	Adrenal cortical hormone	CHP20/C04	5-9	36
5-Hydroxytryptophan	Amino acid	CHP20/C04	5-2	34
D-2-Hydroxy-n-butyric acid	D- α -Hydroxycarboxylic acid	CRS10W	6-17	55
L-2-Hydroxy-n-butyric acid	L- α -Hydroxycarboxylic acid	CRS10W	6-17	55
D- α -Hydroxy isocaproic acid	D- α -Hydroxycarboxylic acid	CRS10W	6-17	55
L- α -Hydroxy isocaproic acid	L- α -Hydroxycarboxylic acid	CRS10W	6-17	55
5-hydroxy lysine	Amino acid	CK10U	2-37	18
D- α -Hydroxy-n-valeric acid	D- α -Hydroxycarboxylic acid	CRS10W	6-17	55
L- α -Hydroxy-n-valeric acid	L- α -Hydroxycarboxylic acid	CRS10W	6-17	55
D-m-Hydroxymandelic acid	D- α -Hydroxycarboxylic acid	CRS10W	6-18	55
L-m-Hydroxymandelic acid	L- α -Hydroxycarboxylic acid	CRS10W	6-18	55
D-p-Hydroxymandelic acid	D- α -Hydroxycarboxylic acid	CRS10W	6-18	55
L-p-Hydroxymandelic acid	L- α -Hydroxycarboxylic acid	CRS10W	6-18	55
D-P-Hydroxy phenylglycine	D-Amino acid	CRS10W	6-20	55
L-P-Hydroxy phenylglycine	L-Amino acid	CRS10W	6-20	55
Hydroxy proline	Amino acid	CK10U	2-35	18
Hypoxanthine	6-Hydroxypurine	CHP20/C04	5-6	35
Hypoxanthine	Nucleic base	CHK40/C04	5-25	43
Hypoxanthine	Nucleic base	CHK45/C05	5-33	46
Inosine	Nucleoside	CHK40/C04	5-25	43
Inosine	Nucleoside	CHK45/C05	5-33	46
Insulin human recombinant	Peptide	CHP20/C10	5-20	41
Insulin glargine	Peptide	CHP20/C10	5-20	41
Insulin human recombinant	Peptide	CMG20/C10	5-20	41
Insulin glargine	Peptide	CMG20/C10	5-20	41
Irbesartan	Sartan	CHK40/C04	5-28	45
Isoleucine	Amino acid	CK10U	2-32	17
Isoleucine	Amino acid	CK10U	2-36	18
D-Isoleucine	D-Amino acid	CRS10W	6-1	52
L-Isoleucine	L-Amino acid	CRS10W	6-1	52
allo-D-Isoleucine	D-Amino acid	CRS10W	6-1	52
allo-L-Isoleucine	L-Amino acid	CRS10W	6-1	52
Isopropyl alcohol	Alcohol	CK08EH	2-15	11
Kinase	Enzyme	DA01	4-3	28
Lactic acid	Carboxylic acid	CK08EH	2-13	11
Lactic acid	Carboxylic acid	CA08F	2-39	19
Lactic acid	Carboxylic acid	CA08F	2-41	20
Lactic acid	Carboxylic acid	CA08F	2-42	20
D-Lactic acid	D- α -Hydroxycarboxylic acid	CRS10W	6-11	53
L-Lactic acid	L- α -Hydroxycarboxylic acid	CRS10W	6-11	53
D-Lactic acid	D- α -Hydroxycarboxylic acid	CRS10W	6-17	55
L-Lactic acid	L- α -Hydroxycarboxylic acid	CRS10W	6-17	55
D-Lactic acid	D- α -Hydroxycarboxylic acid	CRS10W/CRS15W	6-22	56
L-Lactic acid	L- α -Hydroxycarboxylic acid	CRS10W/CRS15W	6-22	56
β -Lactoglobulin	Protein	CMG20/C10	5-18	40
Lactose	Disaccharide	CK08EC	2-1	7
Lactose	Disaccharide	CK08EC	2-3	7
Lactose	Disaccharide	CK06SC	2-19	12
Lactose	Disaccharide	CA08F	2-38	19
Lactose monohydrate	Disaccharide	CK08EC	2-10	9
Lactulose	Disaccharide	CK08EC	2-3	7
Lactulose	Disaccharide	CK06SC	2-19	12
Leucine	Amino acid	CK10U	2-32	17

Compound	Classification	MCI GEL™ column	Figure	Page
Leucine	Amino acid	CK10U	2-36	18
Nor-Leucine	Amino acid	CK10U	2-36	18
D-Leucine	D-Amino acid	CRS10W	6-2	53
L-Leucine	L-Amino acid	CRS10W	6-2	53
Leu-Enkephalin	Peptide	CMG20/C04	5-12	38
Leuprorelin	Peptide	CHP20/C10	5-22	42
Leuprorelin	Peptide	CMG20/C10	5-22	42
LH-RH human	Peptide	CHP20/C10	5-22	42
LH-RH human	Peptide	CMG20/C10	5-22	42
LH-RH salmon	Peptide	CHP20/C10	5-22	42
LH-RH salmon	Peptide	CMG20/C10	5-22	42
Linalool	Perfume	CMG20/C10	5-26	44
Linalool	Perfume	CMG20/C10	5-27	44
Linalyl acetate	Perfume	CMG20/C10	5-26	44
Lithium ion	Cation	SCK01	3-1	22
Lithium ion	Cation	CHK45/C05	3-10	23
Losartan	Sartan	CHK40/C04	5-28	45
Lysine	Amino acid	CK10U	2-32	17
Lysine	Amino acid	CK10U	2-37	18
D-Lysine	D-Amino acid	CRS10W	6-8	53
L-Lysine	L-Amino acid	CRS10W	6-8	53
Magnesium ion	Cation	SCK01	3-7	23
Magnesium ion	Cation	SCK01	3-9	23
Magnesium ion	Cation	CHK45/C05	3-10	23
Malic acid	Carboxylic acid	CK08EH	2-13	11
Malic acid	Carboxylic acid	CA08F	2-39	19
Malic acid	Carboxylic acid	CA08F	2-41	20
Malonic acid	Carboxylic acid	CK08EH	2-13	11
Malonic acid	Carboxylic acid	CA08F	2-39	19
Maltose	Disaccharide	CA08F	2-38	19
Maltose	Disaccharide	CK08E	2-12	10
Maltotriose	Disaccharide	CK08E	2-12	10
D-Mandelic acid	D- α -Hydroxycarboxylic acid	CRS10W	6-18	55
L-Mandelic acid	L- α -Hydroxycarboxylic acid	CRS10W	6-18	55
Manganese ion	Cation	SCK01	3-8	23
Mannitol	Sugar alcohol	CK08EC	2-1	7
Mannitol	Sugar alcohol	CK08EC	2-8	8
Mannitol	Sugar alcohol	CK08EC	2-9	9
Mannitol	Sugar alcohol	CK08EC	2-10	9
Mannose	Sugar	CK08EC	2-1	7
Mannose	Sugar	CK08EC	2-10	9
Mannose	Sugar	CA08F	2-38	19
Melibiose	Disaccharide	CA08F	2-38	19
Met-Enkephalin	Peptide	CMG20/C04	5-12	38
Methionine	Amino acid	CK10U	2-32	17
D-Methionine	D-Amino acid	CRS10W	6-3	53
L-Methionine	L-Amino acid	CRS10W	6-3	53
D-Methionine	D-Amino acid	CRS10W	6-14	54
L-Methionine	L-Amino acid	CRS10W	6-14	54
Methyl alcohol	Alcohol	CK08EH	2-15	11
Methylamine	Amine	SCK01	3-2	22
γ -methyl leucine	Amino acid	CK10U	2-36	18
Mevastatin	Medicine	CHP20/C10	5-16	39
Myoglobin	Protein	CQP30	4-6	30
Nerol	Perfume	CMG20/C10	5-26	44
Nitrate ion	Anion	SCA04	3-11	24
Nitrate ion	Anion	SCA04	3-12	24
Nitrate ion	Anion	SCA04	3-13	24
Nitrate ion	Anion	SCA04	3-14	25
Nitrate ion	Anion	SCA04	3-16	25
Nitrate ion	Anion	SCA04	3-11	24
Nitrate ion	Anion	SCA04	3-12	24
D-Norleucine	D-Amino acid	CRS10W	6-3	53
L-Norleucine	L-Amino acid	CRS10W	6-3	53
D-Norvaline	D-Amino acid	CRS10W	6-3	53

Compound	Classification	MCI GEL™ column	Figure	Page
L-Norvaline	L-Amino acid	CRS10W	6-3	53
Nystatin	Antibiotic	CHP20/C10	5-17	39
Oligosaccharide	Dp1-Dp9	CK04S	2-21	15
Oligosaccharide	Dp1-Dp13	CK04SS	2-22	15
Oligosaccharide	Dp1-Dp16	CK02A	2-23	15
Oligosaccharide	Dp1-Dp20	CK02AS	2-24	15
Oligosaccharide	Dp1-Dp7	CK04S	2-25	16
Oligosaccharide	Dp1-Dp7	CK04SS	2-26	16
Oligosaccharide	Dp1-Dp7	CK02AS	2-27	16
Ornithine	Amino acid	CK10U	2-37	18
Orotic acid	Carboxylic acid	CHP20/C04	5-6	35
Ovalbumin	Protein	CQP30	4-6	30
Oxalic acid	Carboxylic acid	CK08EH	2-13	11
PEG MW 145,000	PEG	CQP30	4-5	30
PEG MW 40,000	PEG	CQP30	4-5	30
PEG MW 6,000	PEG	CQP30	4-5	30
Penicillin G	Antibiotic	CHP50/P20	5-35	48
Penicillin V	Antibiotic	CHP50/P20	5-35	48
Phenacetin	Medicine	CMG20/C04	5-10	37
Phenylalanine	Amino acid	CK10U	2-32	17
Phenylalanine	Amino acid	CK10U	2-37	18
D-Phenylalanine	D-Amino acid	CRS10W	6-2	53
L-Phenylalanine	L-Amino acid	CRS10W	6-2	53
D-Phenylalanine	D-Amino acid	CRS10W	6-9	53
L-Phenylalanine	L-Amino acid	CRS10W	6-9	53
D- α -Phenyglycine	D-Amino acid	CRS10W	6-13	54
L- α -Phenyglycine	L-Amino acid	CRS10W	6-13	54
Phosphate ion	Anion	SCA04	3-11	24
Pipecolic acid	Amino acid	CK10U	2-35	18
Polyphenon 60	Polyphenol	CHP07/C04	5-29	45
Polyphenon 60	Polyphenol	CHP20/C04	5-30	45
Potassium ion	Cation	SCK01	3-1	22
Potassium ion	Cation	SCK01	3-3	22
Potassium ion	Cation	SCK01	3-4	22
Potassium ion	Cation	SCK01	3-5	22
Potassium ion	Cation	CHK45/C05	3-10	23
Pravastatin Na	Medicine	CHP20/C10	5-16	39
Procainamide	Anesthetic	CMG20/C04	5-14	38
Procaine	Anesthetic	CMG20/C04	5-14	38
Proline	Amino acid	CK10U	2-32	17
Proline	Amino acid	CK10U	2-35	18
D-Proline	D-Amino acid	CRS10W	6-2	53
L-Proline	L-Amino acid	CRS10W	6-2	53
n-Propyl alcohol	Alcohol	CK08EH	2-15	11
Pyruvic acid	Carboxylic acid	CA08F	2-41	20
Quinine	Cinchona alkaloid	CHP20/C04	5-5	34
Rhamnose	Sugar	CA08F	2-38	19
Ribitol(Adnitol)	Sugar alcohol	CK08EC	2-10	9
Ribonuclease A	Protein	CMG20/C04	5-13	38
Ribonuclease A	Protein	CMG20/C10	5-18	40
Ribonuclease A	Protein	CHP20/C10	5-19	40
Ribose	Sugar	CK08EC	2-1	7
Ribose	Sugar	CK08EC	2-10	9
Ribose	Sugar	CA08F	2-38	19
Rituximab	Monoclonal antibody	SP01	4-1	28
Rubidium ion	Cation	SCK01	3-1	22
Salicin	Phenol glycoside	CK08EC	2-1	7
Salicin	Phenol glycoside	CK08EC	2-10	9
Senoside A	Senoside A	CHP20/C10	5-37	49
Senoside B	Senoside B	CHP20/C10	5-37	49
Senoside A	Senoside A	CHP20/P20	5-37	49
Senoside B	Senoside B	CHP20/P20	5-37	49
Senoside A	Senoside A	CHP20/P30	5-37	49
Senoside B	Senoside B	CHP20/P30	5-37	49
Senoside A	Senoside A	CHP20/P30	5-38	49

Compound	Classification	MCI GEL™ column	Figure	Page
Serine	Amino acid	CK10U	2-32	17
D-Serine	D-Amino acid	CRS10W	6-4	53
L-Serine	L-Amino acid	CRS10W	6-4	53
Serotonin	Catecholamine	CHP20/C04	5-2	34
Sifuvirtide	Peptide	CMG20/C10	5-23	42
Simvastatin	Medicine	CHP20/C10	5-16	39
Sodium ion	Cation	SCK01	3-1	22
Sodium ion	Cation	SCK01	3-3	22
Sodium ion	Cation	SCK01	3-4	22
Sodium ion	Cation	SCK01	3-5	22
Sodium ion	Cation	CHK45/C05	3-10	23
Sorbitol	Sugar alcohol	CK08EC	2-2	7
ssRNA	RNA	CHP20/C10	5-24	43
Stachyose	Tetrasaccharide	CK08EC	2-1	7
Stachyose hydrate	Sugar	CK08EC	2-10	9
Strontium ion	Cation	SCK01	3-7	23
Strontium ion	Cation	SCK01	3-8	23
Succinic acid	Carboxylic acid	CA08F	2-41	20
Succinylsulfathiazole	Sulfa drug	CMG20/C04	5-11	37
Sucrose	Disaccharide	CK08EC	2-2	7
Sucrose	Disaccharide	CK08EC	2-4	8
Sucrose	Disaccharide	CK08EC	2-5	8
Sucrose	Disaccharide	CK08EC	2-11	10
Sucrose	Disaccharide	CK04S	2-30	16
Sulfate ion	Anion	SCA04	3-11	24
Sulfate ion	Anion	SCA04	3-12	24
Sulfate ion	Anion	SCA04	3-13	24
Sulfamerazine	Sulfa drug	CMG20/C04	5-11	37
Sulfanilamide	Sulfa drug	CMG20/C04	5-11	37
Sulfathiazole	Sulfa drug	CMG20/C04	5-11	37
Tartaric acid	Carboxylic acid	CK08EH	2-13	11
Tartaric acid	Carboxylic acid	CA08F	2-39	19
Tartaric acid	Carboxylic acid	CA08F	2-41	20
Tert-leucine	Amino acid	CK10U	2-36	18
Theobromine	Purine alkaloid	CHP20/C04	5-4	34
Theophylline	Purine alkaloid	CHP20/C04	5-4	34
Theophylline	Purine alkaloid	CHP20/C04	5-6	35
Thiocyanic ion	Anion	SCA04	3-15	25
Thiosulfuric ion	Anion	SCA04	3-15	25
Threonine	Amino acid	CK10U	2-32	17
Thymidine	Nucleoside	CHK40/C04	5-25	43
Thymidine	Nucleoside	CHK45/C05	5-33	46
Thymine	Nucleic base	CHK40/C04	5-25	43
D-α-Tocopherol	Vitamin	CMG20/C04	5-41	51
D-γ-Tocopherol	Vitamin	CMG20/C04	5-41	51
D-δ-Tocopherol	Vitamin	CMG20/C04	5-41	51
D-α-Tocopherol	Vitamin	CMG20/P30	5-42	51
D-γ-Tocopherol	Vitamin	CMG20/P30	5-42	51
D-δ-Tocopherol	Vitamin	CMG20/P30	5-42	51
D-α-Tocopherol	Vitamin	CMG20/C04	5-43	51
D-β-Tocopherol	Vitamin	CMG20/C04	5-43	51
D-γ-Tocopherol	Vitamin	CMG20/C04	5-43	51
D-δ-Tocopherol	Vitamin	CMG20/C04	5-43	51
D-α-Tocopherol	Vitamin	CMG20/C10	5-41	51
D-γ-Tocopherol	Vitamin	CMG20/C10	5-41	51
D-δ-Tocopherol	Vitamin	CMG20/C10	5-41	51
D-γ-Tocotrienol	Vitamin	CMG20/C04	5-41	51
D-γ-Tocotrienol	Vitamin	CMG20/P30	5-42	51
D-α-Tocotrienol	Vitamin	CMG20/C04	5-43	51
D-β-Tocotrienol	Vitamin	CMG20/C04	5-43	51
D-γ-Tocotrienol	Vitamin	CMG20/C04	5-43	51
D-δ-Tocotrienol	Vitamin	CMG20/C04	5-43	51
D-γ-Tocotrienol	Vitamin	CMG20/C10	5-41	51
Transferrin	Protein	CMG20/C10	5-18	40
Trichloroacetic acid	Carboxylic acid	CK08EH	2-16	12

Compound	Classification	MCI GEL™ column	Figure	Page
Triethylene glycol	Polyalcohol	CK08EH	2-17	12
Trimethylamine	Amine	SCK01	3-2	22
TritonX-100	Surfactant	CHPOD/04	5-31	46
Tryptophan	Amino acid	CHP20/C04	5-2	34
L-Tryptophan	L-Amino acid	CRS10W	6-10	53
Tyrosine	Amino acid	CK10U	2-32	17
Tyrosine	Amino acid	CK10U	2-37	18
D-Tyrosine	D-Amino acid	CRS10W	6-2	53
L-Tyrosine	L-Amino acid	CRS10W	6-2	53
UMP	Nucleotide	CHK45/C05	5-33	46
Uracil	Nucleic base	CHK40/C04	5-25	43
Uracil	Nucleic base	CHK45/C05	5-33	46
Uric acid	2,6,8-Trioxypurine	CHP20/C04	5-6	35
Uridine	Nucleoside	SCK01	3-6	22
Uridine	Nucleoside	CHK40/C04	5-25	43
Uridine	Nucleoside	CHK45/C05	5-33	46
Ursodeoxycholic acid	Bile acid	CHP20/C04	5-7	35
Valine	Amino acid	CK10U	2-32	17
Valine	Amino acid	CK10U	2-33	18
Valine	Amino acid	CK10U	2-36	18
D-Valine	D-Amino acid	CRS10W	6-2	53
L-Valine	L-Amino acid	CRS10W	6-2	53
Valsartan	Sartan	CHK40/C04	5-28	45
Vitamin B3	Water soluble vitamin	CMG20/C04	5-15	38
Vitamin B6	Water soluble vitamin	CMG20/C04	5-15	38
Vitamin B12	Water soluble vitamin	CMG20/C04	5-15	38
Vitamin C	Water soluble vitamin	CMG20/C04	5-15	38
Xanthine	2,6-Dihydroxypurine	CHP20/C04	5-6	35
Xanthine	Nucleic base	CHK40/C04	5-25	43
Xanthine	Nucleic base	CHK45/C05	5-33	46
Xanthine oxidase	Nucleic base	CHK45/C05	5-33	46
Xanthosine	Nucleoside	CHK40/C04	5-25	43
Xylitol	Sugar alcohol	CK08EC	2-1	7
Xylitol	Sugar alcohol	CK08EC	2-10	9
Xylose	Sugar	CA08F	2-38	19
Zinc ion	Cation	SCK01	3-7	23

Limited warranty

Mitsubishi Chemical Corporation warrants that its pre-packed columns (including separation media products) shall meet published specifications at the time of shipment from Mitsubishi Chemical Corporation. Because of the susceptibility of these products to deterioration, all warranty claims must be made within the stipulated in the listed sales office. All claims shall be deemed waived in the event the purchaser fails to notify the company within the period.

Conditions

A. The products in this brochure are for laboratory or manufacturing use. They are not intended for drug, medicine, food additive or household use. Compliance with local and government regulations concerning their use is the responsibility of the purchaser.

B. Voiding of warranty :

This warranty is null and void if any product has been (1) altered or modified such that its stability or reliability is any way affected ; (2) misused ; or (3) damaged by abuse, negligence or accident. The term "misuse" includes, but is not limited to, use not in compliance with the "Column Handling Instructions".

C. Limitations and Exclusions :

All recommendations, information and descriptions supplied by Mitsubishi Chemical Corporation with respect to any product in this brochure are believed to be accurate and reliable, but do not constitute warranties. The sole liability of Mitsubishi Chemical Corporation for any breach of warranty is limited to replacement, or at the sole option of Mitsubishi Chemical Corporation a refund of the purchase price.

Changes

All specifications, quantities, designs and prices are subject to change without notice.

General

Neither this publication, nor any products in this brochure shall be construed as recommending the infringement of any patent, nor extending any license, express or implied, nor assuming any liability under any issued or pending patent. The data presented herein have been carefully compiled from our records which we believe to be accurate and reliable. We make, however, no warranties or representations with respect hereto, nor is freedom from any patent to be inferred.



Related Product Lineup

D I A I O N™

S E P A B E A D S™

Ion Exchange Resins (DIAION™)

Strongly Acidic Cation Exchange Resins
(Gel, Porous, Highly Porous Type and Industrial Chromatography)
DIAION™ SK, UBK, PK series

Weakly Acidic Cation Exchange Resins
(Methacrylic and Acrylic Type)
DIAION™ WK series

Strongly Basic Anion Exchange Resins
(Gel, Porous, and Highly Porous Type)
DIAION™ SA, UBA, PA, HPA series

Weakly Basic Anion Exchange Resins
(Acrylic, Polyamine, and Dimethylamine Type)
DIAION™ WA series

Chelating Resins (DIAION™)

Iminodiacetate type, Polyamine Type, and Glucamine Type
DIAION™ CR series

Synthetic Adsorbents (DIAION™/SEPABEADS™)

Aromatic Type, Modified Aromatic Type, and Methacrylic Type
DIAION™ HP series
SEPABEADS

please visit

<http://www.diaion.com/en>

Mitsubishi Chemical Corporation

1-1, Marunouchi 1-chome, Chiyoda-ku, Tokyo 100-8251, Japan
TEL: +81-3-6748-7146

- The information and data contained in this brochure are as of December, 2021.
- The content of this brochure may be changed without prior notice.
- Due to printing characteristics, the color tones may differ from the actual ones.
- The transcription of any information or data contained in this brochure without prior written consent is strictly prohibited.